

## TECHNICAL MANUAL

TAP WATER INSTALLATION  
RADIATOR CONNECTION  
RADIANT HEATING/COOLING



*ALU  
MULTI-LAYER PIPE  
+ PRESS-FITTING  
+ PUSH-FITTING  
+ WELD-FITTING  
= 1 SYSTEM*

made in germany



# CONTENT

<b>P. 4</b>	<b>Technical Manual</b>				
<b>P. 4</b>	<b>1.0.</b>	<b>System description</b>	<b>P. 18</b>	<b>5.0.</b>	<b>Technical information sanitary application</b>
P. 4	<b>1.1.</b>	<b>MULTITUBO systems</b> – multi-layer pipe	P. 18	<b>5.1.</b>	General information
P. 5	<b>1.1.1.</b>	Technical data multi-layer pipe	P. 18	<b>5.2.</b>	Basis of design
P. 6	<b>1.2.</b>	Connection techniques	P. 18	<b>5.2.1.</b>	Dimensioning
P. 6	<b>1.2.1.</b>	Metal-Press-Fitting, 16 mm - 32 mm	P. 19	<b>5.2.2.</b>	Pipe friction resistance
P. 6	<b>1.2.2.</b>	PPSU-Press-Fitting, 16 mm - 50 mm	P. 21	<b>5.2.3.</b>	Pressure loss diagram
P. 6	<b>1.2.3.</b>	Metal-Press-Fitting, 40 mm - 75 mm	P. 21	<b>5.3.</b>	Pressure test and pipe flushing
P. 7	<b>1.2.4.</b>	MODULAR 90/110 Metal-Press-Fittings, 63 mm - 110 mm	P. 21	<b>5.3.1.</b>	Pressure test with water
P. 7	<b>1.2.5.</b>	Zeta-Values press systems	P. 22	<b>5.3.2.</b>	Pressure test with air or inert gases
P. 7	<b>1.2.6.</b>	Push-Fitting, 16 mm - 32 mm	P. 22	<b>5.3.3.</b>	Pipe flushing
P. 8	<b>1.2.7.</b>	Welding-Fitting, 16 mm - 75 mm	P. 22	<b>5.3.4.</b>	Pressure test protocol
P. 8	<b>1.3.</b>	Tools			
<b>P. 9</b>	<b>2.0.</b>	<b>Fields of application</b>	<b>P. 22</b>	<b>6.0.</b>	<b>Technical information radiator connection</b>
<b>P. 10</b>	<b>3.0.</b>	<b>Installation and assembly instructions</b>	P. 22	<b>6.1.</b>	General information
P. 10	<b>3.1.</b>	Mounting instructions	P. 23	<b>6.2.</b>	Pressure loss graph
P. 10	<b>3.1.1.</b>	Preparation of the connection	P. 24	<b>6.3.</b>	Heat capacity
P. 10	<b>3.1.2.</b>	Press-Fitting 16 – 32 mm	P. 24	<b>6.4.</b>	Pressure test
P. 10	<b>3.1.3.</b>	Press-Fitting 40 – 75 mm	P. 24	<b>6.4.1.</b>	Pressure test protocol for radiator connection
P. 11	<b>3.1.4.</b>	Press-Fitting MODULAR 90/110 63 mm - 110 mm			
P. 11	<b>3.1.5.</b>	Use of the pressing jaws	<b>P. 25</b>	<b>7.0.</b>	<b>Technical information radiant heating/cooling</b>
P. 12	<b>3.1.6.</b>	Push-Fitting 16 – 32 mm	P. 25	<b>7.1.</b>	General Information
P. 12	<b>3.1.7.</b>	Welding-Fitting 16 - 75 mm	P. 26	<b>7.2.</b>	Laying systems
P. 12	<b>3.1.8.</b>	Screw-Fitting 16 – 20 mm	P. 26	<b>7.3.</b>	Fringe area
P. 13	<b>3.2.</b>	Installation measures	P. 26	<b>7.4.</b>	Expansion joints
P. 13	<b>3.3.</b>	Thermal expansion	P. 27	<b>7.5.</b>	Calculation diagram underfloor heating
P. 14	<b>3.4.</b>	Distribution-lines and Risers	P. 28	<b>7.6.</b>	Pressure-loss diagram
P. 14	<b>3.5.</b>	Bending leg length	P. 28	<b>7.7.</b>	Pipe spacing and corresponding pipe demand
P. 14	<b>3.6.</b>	Fastening technique	P. 28	<b>7.8.</b>	Pressure test
P. 14	<b>3.6.1.</b>	Pipe fastening on ceiling and wall	P. 28	<b>7.8.1.</b>	Pressure test protocol for panel heating
P. 15	<b>3.6.2.</b>	Pipe fastening on the bare floor			
P. 15	<b>3.7.</b>	Pipe bending / bending radii	<b>P. 28</b>	<b>8.0.</b>	<b>Service</b>
<b>P. 16</b>	<b>4.0.</b>	<b>General technical information</b>	<b>P. 29</b>		<b>Warranty</b>
P. 16	<b>4.1.</b>	Potential equalisation			
P. 16	<b>4.2.</b>	Use of rainwater			
P. 16	<b>4.3.</b>	Installation in mastic asphalt			
P. 16	<b>4.4.</b>	Sink heater			
P. 16	<b>4.5.</b>	Heat tracing			
P. 16	<b>4.6.</b>	Freeze protection			
P. 16	<b>4.7.</b>	Fire protection			
P. 16	<b>4.7.1.</b>	Building material class			
P. 16	<b>4.7.2.</b>	Fire classification			
P. 16	<b>4.8.</b>	Legionella			
P. 16	<b>4.9.</b>	Installation in risk-exposed areas			
P. 16	<b>4.10.</b>	Installation in concrete, screed and in-wall			
P. 17	<b>4.11.</b>	Installation in the soil, outdoor			
P. 17	<b>4.12.</b>	Application in pressurised air systems			
P. 17	<b>4.13.</b>	Mounting instructions of screw connections			
P. 17	<b>4.14.</b>	Storage and assembly requirements			

All information in this manual is compiled to the best of our knowledge. No liability can be assumed for possible faults.  
**We reserve the right to make technical amendments and carry out updates!**



**1 The Metal-Press-Fitting**

Universal connection-technology from 16 mm up to 110 mm by MULTITUBO systems.

**2 The PPSU-Press-Fitting**

The economical extension to the Metal-Press-Fitting range from 16 mm up to 50 mm.

**3 The Metal-Push-Fitting**

Invincible where press-tools cannot be used or where a rapid installation progress is required – from 16 mm up to 32 mm.

**4 The PPSU-Push-Fitting**

As fast as the Metal-Push-Fitting, with the same safety features, but a still more economic alternative.

**With PROTECTOR-Ring**

The PROTECTOR-Ring prevents insertion of non-calibrated pipes and thus damage of the O-Rings.



**5 The Welding-Fitting**

This cost efficient connection is perfect solution for acrid conditions. With an increased resistance against salt and many other corrosives\*, the Welding-Fitting is the new alternative from 16 mm up to 75 mm.

made in germany

**6 Multilayer Pipes**

With more than 30 years of expertise in the development and production of multilayer pipes, our pipes are an equivalent to highest quality. This enables MULTITUBO systems to offer 5 connection techniques, fully compatible within the same dimension.

A unique advantage that allows the highest possible flexibility at each building site.

ALU  
MULTI-LAYER PIPE

+ PRESS-FITTING  
+ PUSH-FITTING  
+ WELD-FITTING

= 1 SYSTEM

We developed five different connection types, each with its own strength. So the installer can always select the optimal way to complete his installation.

And the best of the MULTITUBO systems is: All these connections are fully compatible within their dimension range. That's the way of success.

\* Please contact us to assure utilisability for your special conditions of use.

## 1.0. System description

### 1.1. MULTITUBO systems – multi-layer pipe

The MULTITUBO systems multi-layer pipe consists of 5 layers. One polyethylene layer is applied to the inside and one to the outside of the welded aluminium pipe. Both PE layers are permanently bonded to the aluminium pipe by means of an adhesive layer. The polyethylene used is a non-cross-linked polyethylene of raised temperature resistance according to

DIN 16833 (PE-RT – polyethylene of raised temperature resistance). The MULTITUBO systems multi-layer pipe is designed for the specific requirements of drinking water and heating installations. The 5-layer structure combines the advantages of plastics and metal.

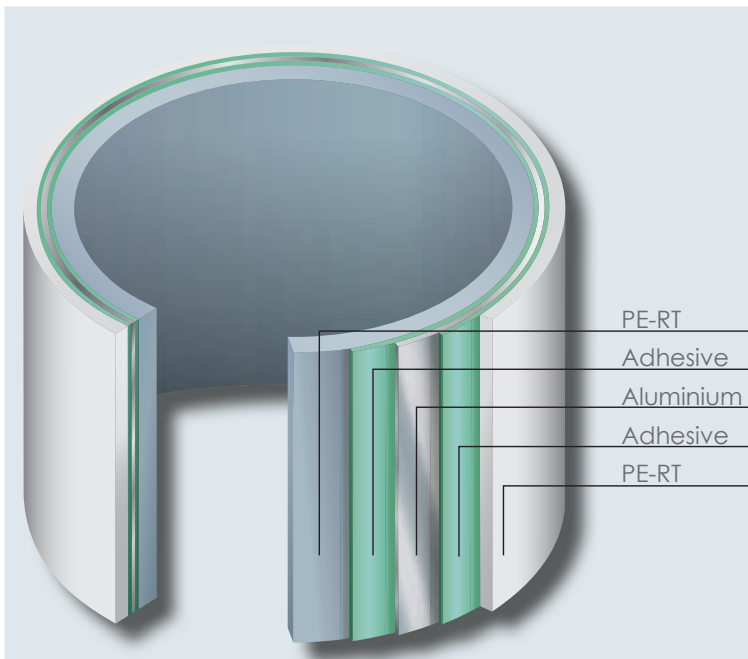

made in germany

#### The low thermal expansion

Due to the inner aluminium layer the thermal expansion is similar to those of metal pipes. Thus the fastening with slide points and fixed points corresponds to those of metal pipes.



#### Easy bendable

Dimensions up to 25 mm can easily be bent by hand. Therefore work can be carried out much more efficient.

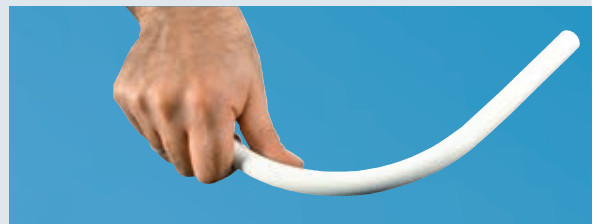

#### Formstable

Once bent, the pipe will keep its shape. This means a significant reduction in fastening points.

Length of pipe	Expansion at $\Delta t$ 50K
PEX	500 mm
PP	450 mm
PB	375 mm
PVC	200 mm
Multitubo	62,50 mm
Copper	41,25 mm
galv. steel	28,50 mm
stainl. steel	27,50 mm

50 m →

#### Highest material safety

Selected raw materials and a continuous experience in production of more than 30 years, guarantee the high quality of a technically perfected product. The high loading capacity of a continuous operating temperature\* exceeds the requirements of the DVGW\*\* test requirements of  $t_{max}$  70 °C (tap water) and  $t_{max}$  80 °C (heating) as well as a continuous operating pressure\* of  $p_{max}$  10 bar as the basis for daily safety.

#### Simple bendability

The standard diameters up to 25 mm can be easily bent without any tools. The bending spring provides exact rounding at narrow bend radii.

#### Advantages of a metal pipe

- absolutely oxygen tight because of welded aluminium pipe
- form stable, no spring back forces
- low thermal expansion

#### Advantages of a plastic pipe

- no deposits because of the smooth inside wall
- no corrosion because of high chemical resistance
- low weight

\* Except pipe qualities with special characteristics in performance (e.g. panel heating, red).

\*\* The DVGW, the German Technical and Scientific Association for Gas and Water is the german technical standardization organisation.

## 1.0. System description

### 1.1. MULTITUBO systems – multi-layer pipe

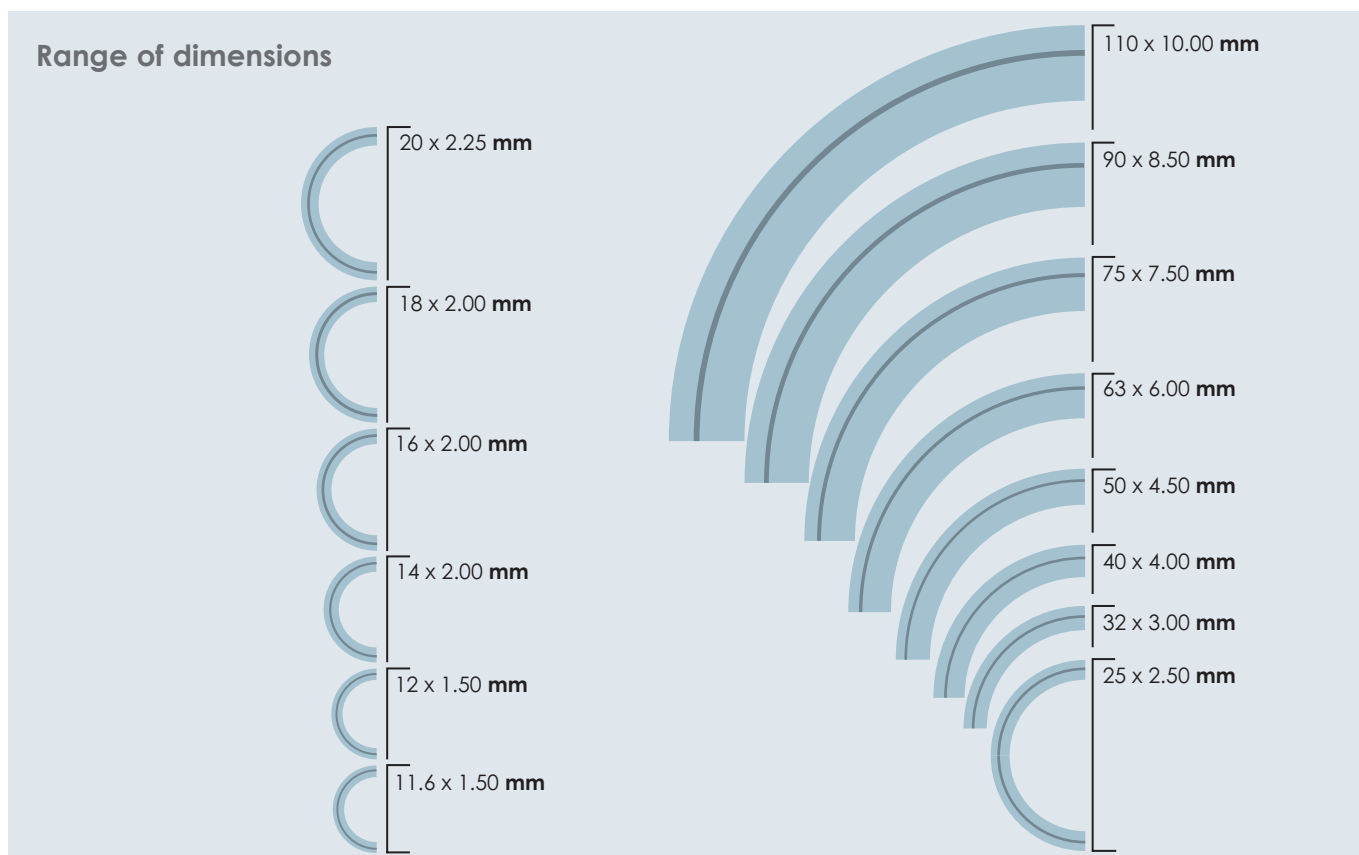

#### 1.1.1. Technical data MULTITUBO systems multi-layer pipes

Pipe dimension	mm	16 x 2.00	18 x 2.00	20 x 2.25	25 x 2.50	32 x 3.00	40 x 4.00	50 x 4.50	63 x 6.00	75 x 7.50	90 x 8.50	110 x 10.00
Inner diameter	mm	12	14	15.5	20	26	32	41	51	60	73	90
Material		PE-RT/AL/PE-RT										
Fire classification		normally inflammable B2 according to DIN 4102 / Euroclass E										
Length, coil (standard)	m	200/500	200	100	50	25	-	-	-	-	-	-
Straight length (standard)	m	5	5	5	5	5	5	5	5	5	5	5
Weight of pipe	kg/m	0.102	0.126	0.145	0.214	0.328	0.500	0.740	1.215	1.777	2.5556	3.625
Water volume	l/m	0.113	0.154	0.190	0.314	0.531	0.803	1.320	2.042	2.827	4,185	6.362
Weight of pipe (filled with water)	kg/m	0.218	0.273	0.338	0.529	0.854	1.310	2.062	3.265	4.615	6.730	9.959
Roughness of surface (inner pipe)	mm	0.0004										
Heat conductivity	W/m x K	0.4										
Expansion coefficient	mm/m x K	0.025										
Min. bending radius (by hand)	mm	80 (5 x d)	90 (5 x d)	100 (5 x d)	125 (5 x d)	160 (5 x d)	-	-	-	-	-	-
Min. bending radius (by bending spring)	mm	60 (4 x d)	72 (4 x d)	80 (4 x d)	100 (4 x d)	125 (4 x d)	-	-	-	-	-	-
Min. bending radius (by bending tool)	mm	50	60	70	90	110	160	200	250	300	-	-

#### Temperature resistance, MULTITUBO systems standard pipe:

**Application tap water:** The daily use of the pipe may not exceed the permanent operating temperature range from 0 °C up to 70 °C and the permanent operating pressure of 10 bar. The maximum short-time accidental temperature is 95 °C and may not occur for longer than 100 operating hours.

**Application heating:** The daily use of the pipe may not exceed the permanent operating temperature range from 0 °C up to 80 °C and the permanent operating pressure of 10 bar. The maximum short-time accidental temperature is 100 °C and may not occur for longer than 100 operating hours.

## 1.0. System description

### 1.2. MULTITUBO systems – Connection techniques

#### 1.2.1. Metal-Press-Fitting, 16 mm - 32 mm

##### The pressing-sleeve

- is fixed to the tin-plated brass body and protects the O-rings from being damaged.
- enables an easy check of the correct insertion-depth due to the inspection windows.
- has a double flange press-jaw guide, that makes a proper pressing easier even at poorly accessible positions.
- keeps the pipe permanently fixed to the fitting body after pressing. The pipe still can be turned and adjusted after the pressing.

##### Additional test safety

- Non-pressed connections can be easily detected during the pre-pressure-test (test pressure 1.5 bar for 15 minutes) by appearance of water.

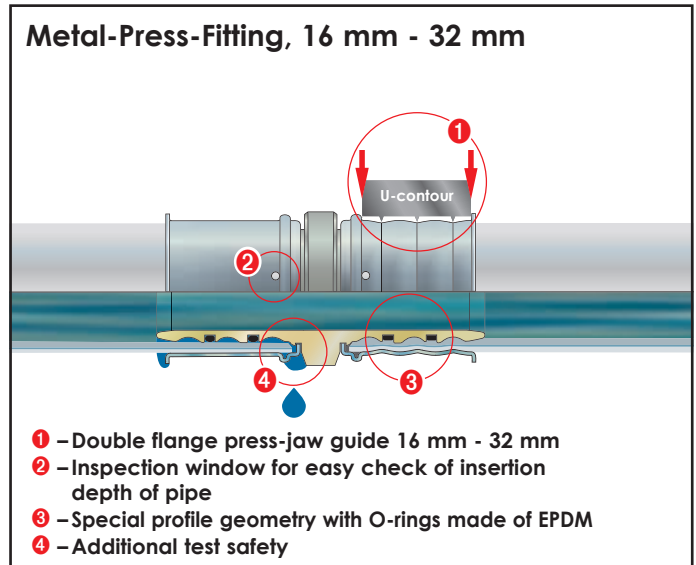

#### 1.2.2. PPSU-Press-Fitting, 16 mm - 50 mm

##### The pressing-sleeve

- is fixed to the PPSU-body and protects the O-rings from being damaged
- enables an easy check of the correct insertion-depth due to the inspection windows.
- has a double flange press-jaw guide, that makes a proper pressing easier even at poorly accessible positions.
- keeps the pipe permanently fixed to the fitting body after pressing. The pipe still can be turned and adjusted after the pressing.

##### Additional test safety

- Non-pressed connections can be easily detected during the pre-pressure-test (test pressure 1.5 bar for 15 minutes) by appearance of water.

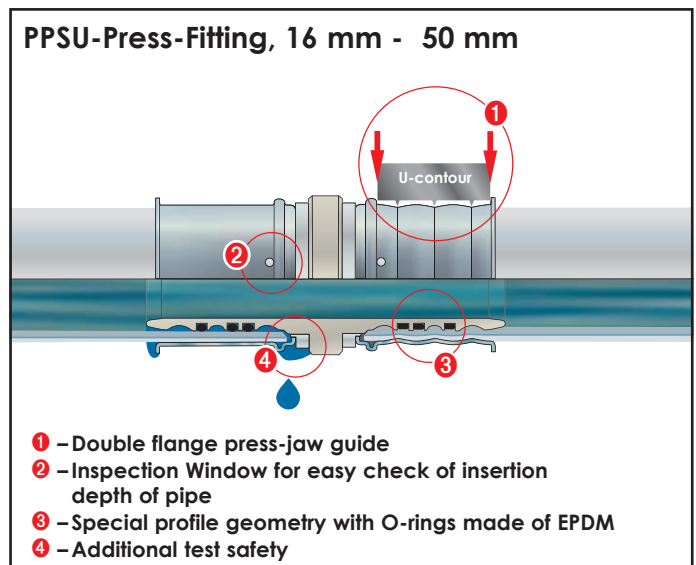

#### 1.2.3. Metal-Press-Fitting, 40 mm - 75 mm

##### The pressing-sleeve

- protects the O-rings from being damaged.
- enables an easy check of the correct insertion-depth due to the inspection windows.

##### The fitting

- has a double flange press-jaw guide, that makes a proper pressing easier.
- keeps the pipe permanently fixed to the fitting body after pressing. The pipe still can be turned and adjusted after the pressing.

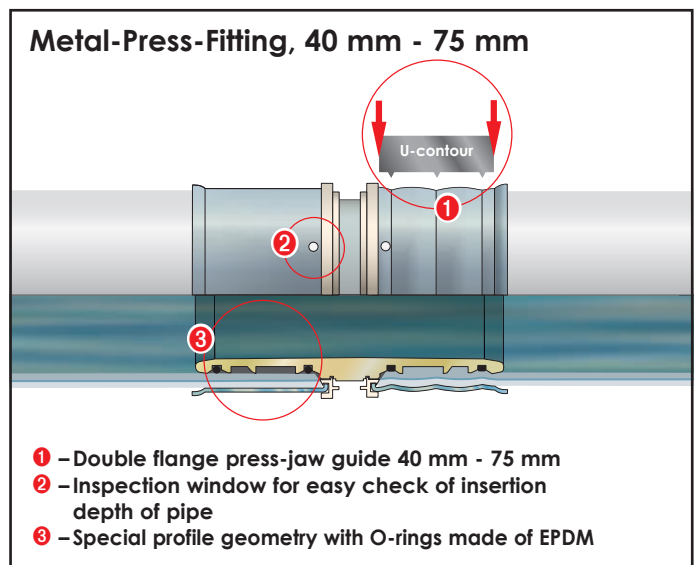

## 1.0. System description

### 1.2. MULTITUBO systems – Connection techniques

#### 1.2.4. MODULAR 90/110 Metal-Press-Fitting, 63 mm - 110 mm

##### The Modular concept

- Pressing adapter is connected to the pipe by pressing.
- Joints, tees or elbows are easily connected to the adapter by gripper clamps.
- Easy realisation of fittings in a project.
- High grade of prefabricated installation steps.

##### Flexible and safe

- Working with premounted parts means higher safety at work. Weight reduced pipes and fittings (compared to traditional metal materials) and easy connecting technique make the handling even over head more safe.

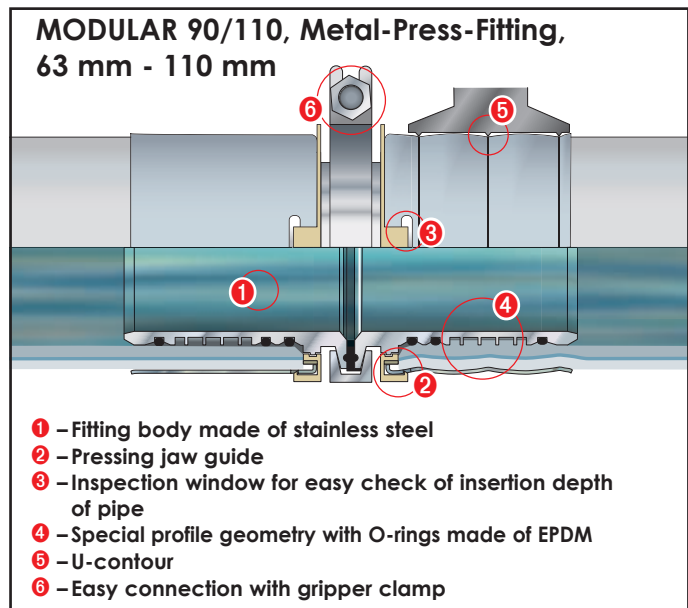

#### 1.2.5. Zeta – values and equivalent pipe length for Metal- and PPSU-Press-Fittings

Dimension $d_a \times s$	mm	16 x 2.00	18 x 2.00	20 x 2.25	25 x 2.50	32 x 3.00	40 x 4.00	50 x 4.50	63 x 6.00	75 x 7.50	90 x 8.50	110 x 10.00											
Inner-diameter $d_i$	mm	12	14	15,5	20	26	32	41	51	60	73	90											
Zeta-value $\zeta$ / equivalent pipe-length $L_a$	m	$\zeta$	$L_a$	$\zeta$	$L_a$	$\zeta$	$L_a$	$\zeta$	$L_a$	$\zeta$	$L_a$	$\zeta$	$L_a$										
Elbow 90°		4.3	2.0	3.6	2.0	2.9	1.9	2.7	2.4	2.3	2.7	2.0	3.1	1.6	3.3	1.4	3.8	1.5	4.6	3.7	15.4	2.9	15.5
Elbow 45°		-	-	-	-	-	-	1.2	1.4	1.2	1.8	0.8	1.7	0.9	2.2	0.9	2.6	0.9	2.6	0.7	2.9	0.6	3.2
Reduction		1.6	0.8	1.4	0.8	1.1	0.8	1.0	0.9	0.9	1.1	0.8	1.2	0.6	1.2	0.7	1.6	0.6	1.6	0.5	2.1	0.7	3.7
Branch at disconnection		5.1	2.4	4.2	2.3	3.5	2.3	3.1	2.7	2.6	3.1	2.4	3.7	1.9	3.9	1.7	4.6	1.8	5.6	3.7	15.4	2.9	15.5
Branch, pass-way at disconnection		1.1	0.6	1.0	0.6	0.8	0.5	0.8	0.7	0.7	0.8	0.5	0.8	0.4	0.8	0.5	1.1	0.5	1.3	0.5	2.1	0.4	2.1
Branch, counter direction at disconnection		4.5	2.1	3.7	2.0	3.1	2.0	2.8	2.5	2.3	2.7	2.1	3.2	1.7	3.5	1.5	4.1	1.6	4.9	2.2	9.1	1.7	9.1

Base: Flow rate of 2 m/s

All information is compiled to the best of our knowledge. No liability can be assumed for possible faults.

#### 1.2.6. Metal-/PPSU-Push-Fitting, 16 mm - 32 mm

##### The PROTECTOR-ring (visible yellow ring on the fitting body)

The PROTECTOR ring secures more safety in the daily work: it prevents an insertion of the pipe when not calibrated and beveled and thus a damage of the O-rings. If the pipe end is correctly prepared, the PROTECTOR ring slides away and gives way for a secure connection.

##### The GRIP-Ring

With the special designed GRIP-Ring, an insertion of the pipe into the fitting is quite easy. Due to the conical guidance the GRIP-Ring – made of high performance plastic – bites into the pipe material and keeps a safe connection.

##### The transparent plastic sleeve

The transparent plastic sleeve gives safe hold for the pipe and equals the force of the grip ring. For utmost safety, the connection the sleeve is well enforced at height of the grip ring.

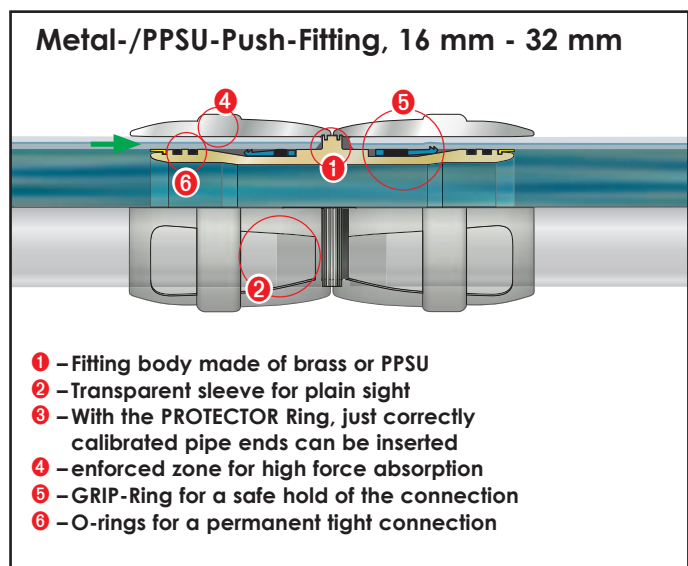





## 2.0. Fields of application

### 2.0. Fields of application

#### Applications

Domestic and building technology, industry applications.

#### Available dimensions

16 x 2.00 mm / 18 x 2.00 / 20 x 2.25 mm / 25 x 2.50 mm / 32 x 3.00 mm / 40 x 4.00 mm / 50 x 4.50 mm / 63 x 6.00 mm / 75 x 7.50 mm / 90 x 8.50 mm / 110 x 10.00 mm

#### Drinking water installation

In its function as a drinking water pipe for cold and hot water of every drinking water quality (according to TrinkwV) MULTITUBO fulfills all requirements of the sanitary technology.

#### Heating installation

In its function as a heating pipe within the mentioned load values, MULTITUBO can be used without limitations for radiator connection or for radiant heating/cooling.

#### Rain water piping

For rain water piping separately laid from drinking water installations within buildings. The ph-value of the water must be > 6.

#### Compressed air

As piping for compressed air in installations with preceding oil filter (oil-free).

#### Automotive engineering

Water transport in vehicles and aeroplanes.

#### Other media

Further media and fields of application on inquiry (e.g. antifreeze and disinfectant).

#### Installation possibilities

##### within the building

- applicable for the installation within buildings in form of surface or concealed installation, of rising main and distributing main systems, as well as for the pre-wall installation with prefabricated fastening options or in concrete components.
- MULTITUBO press connections are permanently tight and thus allowed for concealed installations.

##### in the open-air

- MULTITUBO systems has to be protected reliably from constant direct UV load (solar radiation).

#### Building material class

MULTITUBO systems corresponds to the building material class B2 (normally inflammable) according to DIN 4102 (please see also topic 4.7.).

#### Comparison of the MULTITUBO pipe dimensions with other pipe materials

The dimensions of MULTITUBO systems pipes can be roughly compared with other materials like copper and galvanized steel according to the following list. (Only a hydraulic calculation can provide information on the dimensioning of whole installations.)

DN	MULTITUBO	Copper	Steel
DN 12	16 x 2.00	15 x 1.00	R 3/8
DN 15	20 x 2.25	18 x 1.00	R 1/2
DN 20	25 x 2.50	22 x 1.00	R 3/4
DN 25	32 x 3.00	28 x 1.50	R 1
DN 32	40 x 4.00	35 x 1.50	R 1 1/4
DN 40	50 x 4.50	42 x 1.50	R 1 1/2
DN 50	63 x 6.00	54 x 2.00	R 2
DN 65	75 x 7.50	64 x 2.00	R 2 1/2
DN 80	90 x 8.50	88.9 x 2.00	R 3
DN 100	110 x 10.00	108 x 2.50	R 4

## 3.0. Installation and assembly instructions

### 3.1. Mounting instructions

The mounting instruction must be considered! The components of the system are harmonised and tested. For all work-steps original MULTITUBO Systems tools, or tools that are approved by MULTITUBO systems have to be used.

For outside supplied components we do not incur any warranty. In particular the preparation of the pipes is valid for all types of connection.

#### 3.1.1. Preparation of the connection

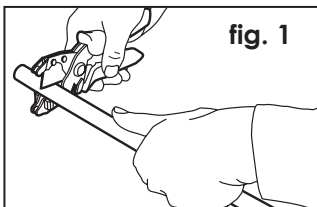

fig. 1

##### 1. CUT TO LENGTH OF THE PIPE

**16 mm – 20 mm (fig. 1)**  
Cut the MULTITUBO systems pipe right-angled with the pipe cutter.

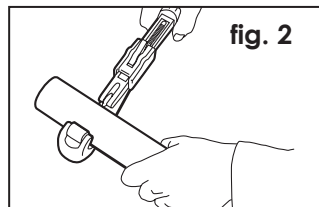

fig. 2

**25 mm - 110 mm (fig. 2)**  
Cut the MULTITUBO systems pipe right-angled with the pipe cutting tool.

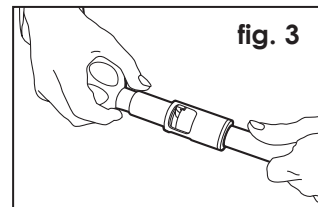

fig. 3

##### 2. CENTERING AND BEVELING OF THE PIPES

**16 mm – 32 mm (fig. 3)**  
Bevel the MULTITUBO systems multi-layer pipe by using the beveling insert in combination with the handle until there is a clearly visible edge all over the pipe end.

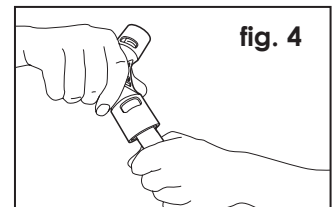

fig. 4

**16 mm / 20 mm / 25 mm (fig. 4)**  
Use the Combined Beveling Tool for press-, push- or welding connections to make a clearly visible edge all over the pipe end.

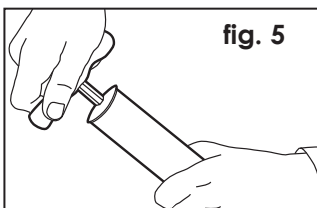

fig. 5

**40 mm – 75 mm (fig. 5)**  
Use the Beveling Tool until there is a clearly visible edge all over the pipe end.

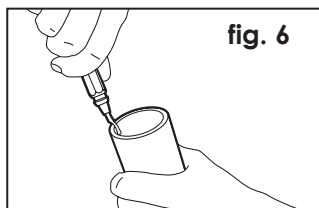

fig. 6

##### IMPORTANT: ONLY FOR WELDING AND MODULAR 90/110 CONNECTIONS

**32 mm – 110 mm (fig. 6)**  
Make a visible edge all over the pipe end by using the Universal Beveling Tool Welding/Modular. Please be aware of the roundness of the pipe!

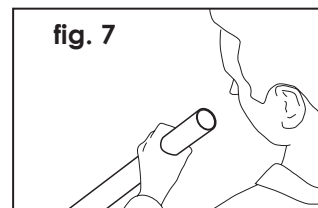

fig. 7

##### 3. INSPECTION OF THE PIPE AND THE FITTING BEFORE INSERTING THE FITTING

Visual inspection of the beveled pipe end and the fitting to identify damages or impurities (fig. 7 + fig. 8). Visual inspection of the beveled pipe end to ensure an equal edge all over (fig. 7 + fig. 9).

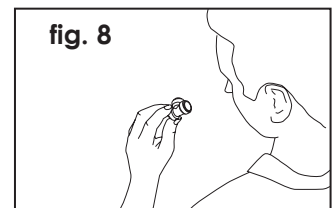

fig. 8

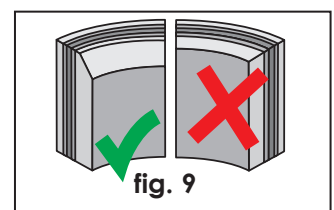

fig. 9

#### 3.1.2. Connections with press fittings 16 mm - 32 mm

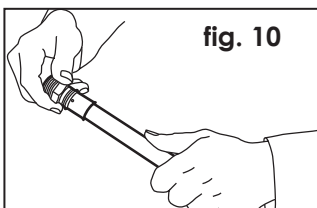

fig. 10

##### 1. ATTACH FITTING TO PIPE

a) Preparation of the MULTITUBO systems multi-layer pipe as described in point 3.1.1.  
b) Push the fitting into the pipe as far as it will go (fig. 10); the correct insertion depth is indicated by the appearance of the pipe in the inspection window of the metal sleeve.

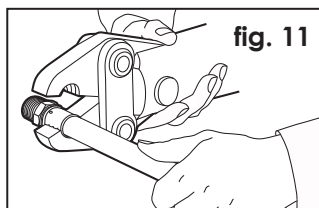

fig. 11

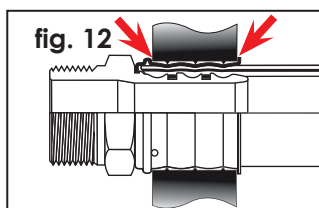

fig. 12

##### 2. PRESSING OF THE FITTING

Open the pressing jaws and position the jaws between the double

guides on the press-sleeve (fig. 11, fig. 12). Close pressing jaws and start pressing procedure.

#### 3.1.3. Connections with press fittings 40 mm - 75 mm

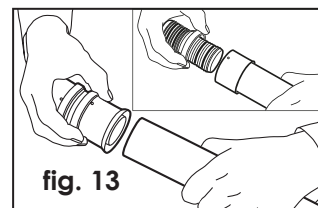

fig. 13

##### 1. ATTACH FITTING TO PIPE

a) Preparation of the MULTITUBO systems multi-layer pipe as described in point 3.1.1.  
b) Push the metal sleeve over the pipe, push the fitting into the pipe as far as it will go (fig. 13). When the fitting lies against the metal sleeve and the pipe can be seen in the inspection window the connection is ready for pressing (fig. 14).

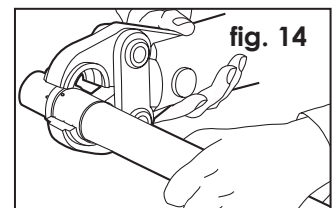

fig. 14

##### 2. PRESSING OF THE FITTING

Open the pressing jaws (75 mm: pressing chain!) and position the jaws on the end-stop of the fitting. Close pressing jaws/pressing chain and start pressing procedure (fig. 15). (Please refer to the instructions supplied with the pressing tool).

### 3.0. Installation and assembly instructions

#### 3.1.4. Press-connection MODULAR 90/110, 63 mm / 75 mm / 90 mm / 110 mm

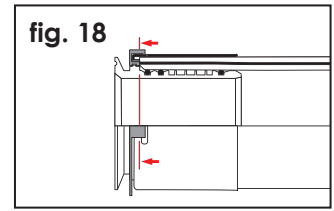
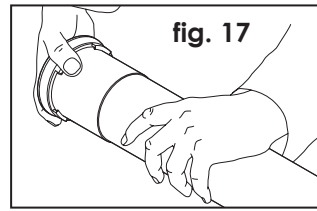
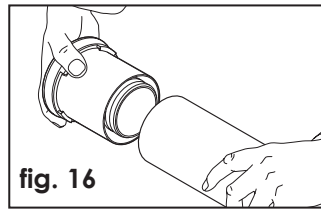
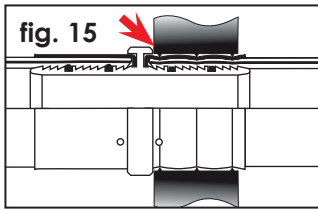

##### 1. ATTACH FITTING TO PIPE

a) Preparation of the MULTITUBO systems multi-layer pipe as described in point 3.1.1. (fig. 2, fig. 6).

b) Push the pipe into the fitting as far as possible (fig. 16, fig. 17); The correct insertion depth is indicated by the appearance of the pipe in the inspection-window of the sleeve (fig. 18).

##### 2. PRESSING OF THE FITTING

Position the pressing-chain at the plastic-stop and connect it with the pressing unit / -device. Start the pressing-procedure. Please be sure that a device with min. 32 Nm of piston force is used (fig. 19, fig. 20).

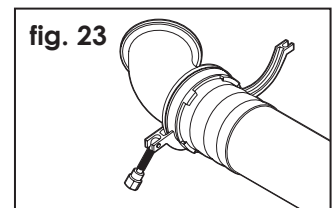
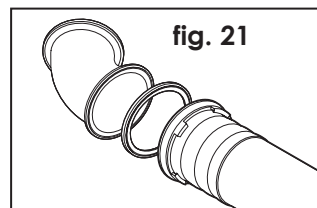
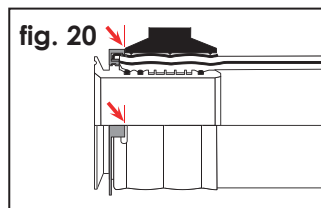
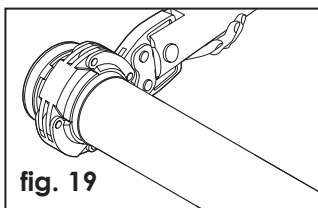

**3. CONNECTING TO BASE BODY OR PRESS ADAPTER**  
Before connecting the base bodies with the press adapter be sure that the joint surfaces and the sealing-ring are undamaged and free of deposits. Place the sealing-ring in the centre of the joint surface,

Place adapter / base body accordingly and fix everything with the gripper clamp (fig. 21, fig. 22). Make sure that the sealing ring is still positioned correctly and tighten the gripper clamp with 7Nm by using a torching wrench (fig. 23, fig. 24).

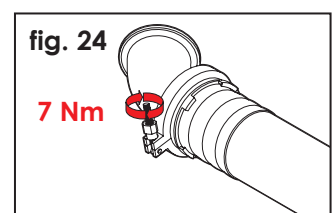
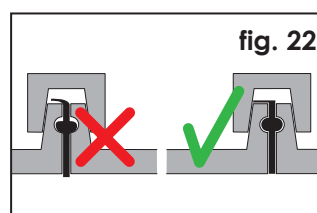

#### 3.1.5. Use of the pressing jaws

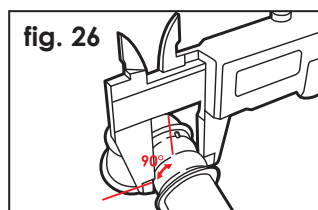
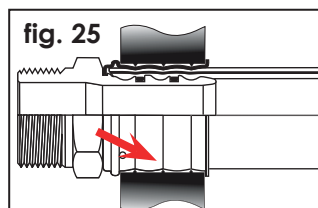

**3. Use of the pressing jaws**  
For the pressing of MULTITUBO systems press fittings, pressing jaws of contour U must be used. It must be ensured that the pressing jaws used are suitable for the application and are in technically perfect conditions. This includes in particular compliance with the following pressing measures after pressing:

Ø 16 pressing measure 16.0 - 16.4 mm	Ø 32 pressing measure 32.0 - 32.3 mm	Ø 75 pressing measure 75.0 - 75.5 mm
Ø 18 pressing measure 18.0 - 18.3 mm	Ø 40 pressing measure 40.0 - 40.5 mm	Ø 90 pressing measure 91.0 - 91.5 mm
Ø 20 pressing measure 20.0 - 20.3 mm	Ø 50 pressing measure 50.0 - 50.5 mm	Ø 110 pressing measure 111.0 - 111.6 mm
Ø 25 pressing measure 25.0 - 25.3 mm	Ø 63 pressing measure 63.0 - 63.5 mm	

The determination of the pressing measures is carried out after the pressing process in the middle pressing groove (fig. 25), 90° of the push of the pressing jaws, respectively central between the bulges of the pressing chains segments (fig. 26).

### General notes on the use of electrical tools and accessories

**1. PRESSING MACHINE**  
**CAUTION: IMPROPER USE MAY RESULT IN SERIOUS INJURY (CRUSHING, ELECTRIC SHOCK).**

For a correct connection

- Only MLTITUBO systems press jaws, or press jaws with U contour in the corresponding dimension may be used.
- The press machine and the press jaws must be in a sound, orderly and maintained condition (according to

manufacturer specifications).  
- The MULTITUBO systems Installation and assembly guidelines must be observed.

**2. WELDING MACHINE**  
**CAUTION: IMPROPER USE MAY RESULT IN SERIOUS INJURY (BURNS, ELECTRIC SHOCK).**

For a correct connection

- Only MLTITUBO systems welding machines and welding inserts may be used.

- Only welding machines and welding inserts in perfect and maintained condition (according to manufacturer's specifications) may be used.

**IMPORTANT: THE OPERATING INSTRUCTIONS ARE BINDING FOR THE USE OF THE RESPECTIVE MACHINE. BEFORE PUTTING THE MACHINE INTO OPERATION THESE ARE TO BE READ AND OBSERVED.**

### 3.0. Installation and assembly instructions

#### 3.1.6. Connections with Push-Fittings 16 mm - 32 mm

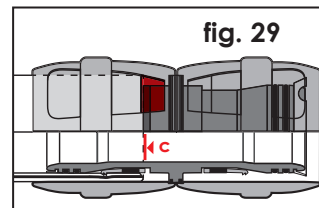
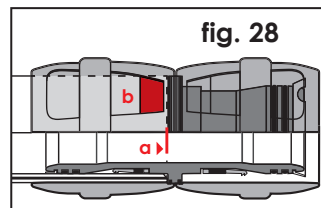
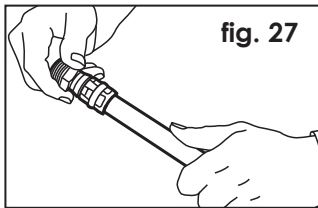

##### 1. ATTACH FITTING TO PIPE

a) Preparation of the MULTITUBO systems multi-layer pipe as described in point 3.1.1.

**IMPORTANT:**  
**FOR CONNECTIONS WITH MULTITUBO SYSTEMS PUSH FITTINGS, THE BEVELING TOOL WITH OUTSIDE GUIDING SLEEVE HAS TO BE USED EXCLUSIVELY!**

b) Push the fitting as far as possible into the pipe (fig. 27, 28, a); the correct insertion depth is indicated if the pipe's end reaches well into the inspection area of the plastic

sleeve (fig. 28, b). The pipe's end may not retreat from this area after the pressure test or during operation (fig. 29, c).

#### 3.1.7. Connections with welding fittings 16 mm - 75 mm

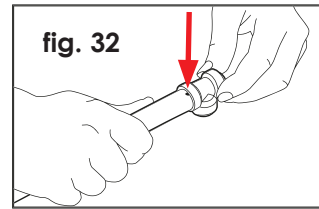
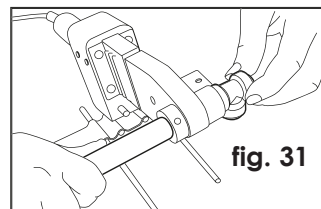
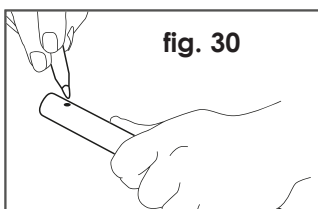

**IMPORTANT TO INSURE A SECURE CONNECTION ALL INSTRUCTIONS, ESPECIALLY THE SAFETY INSTRUCTIONS, TEMPERATURES AND PROCESSING TIMES, MUST BE CONSIDERED.**

a) Preparation of the MULTITUBO systems multi-layer pipe as described under 3.1.1.  
b) For the MULTITUBO systems welding fittings just MULTITUBO systems welding machines must be used.  
c) To insure a perfect connection of pipe and fitting all parts must be free from deposits and free of grease. Eventually the pipe and fitting must be cleaned before wel-

ding and protected against an anew impurity. Be aware that the fittings could not get in touch with grease or other similar materials during storage and transport.  
d) Heat up the welding machine according to the instructions  
e) Mark the insertion depth of the pipe into the fitting on the pipe (see table 1, insertion depth, Technical Manual) (fig. 30).  
f) Insert the pipe into the plug and at the same the fitting onto the socket. Insert straight, don't turn or align (fig. 31)!  
g) The heat up time starts when pipe and fitting are fully inserted.  
h) After the prescribed heat-up

time remove pipe and fitting rapidly from the welding machine and put both directly and without turning / align them together. The correct insertion depth must be checked by the previous marked check mark (fig. 32).  
i) The pipe must not be overheated or inserted too deep. That would cause counterproductive narrowing flow channels by the flowing material.  
j) During the processing-time the connection can be adjusted a little bit but the pipe must not be turned inside the fitting. After that the connection must be fixed to prevent it from unexpected impacts.

k) After the cooling-off time the connection is able to work under full pressure.  
l) Adapter reductions: Equal to connecting pipes with welding fittings, the adapters are welded directly to the fittings. The insertion depth is defined by the fitting design.

**IMPORTANT:**  
**THE INSERTION DEPTHS, THE TIMES FOR HEATING-UP, PROCESSING AND COOLING-OFF ARE MENTIONED IN THE TECHNICAL MANUAL "WELDING" AND MUST BE FOLLOWED! THIS MANUAL IS ENCLOSED TO EACH WELDING MACHINE OR CAN BE REQUESTED FROM US.**

#### 3.1.8. Connections with screw fittings 16 mm - 20 mm

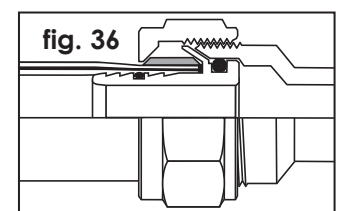
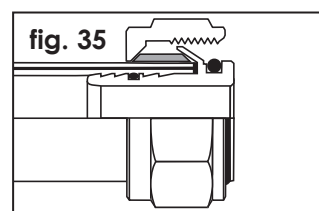
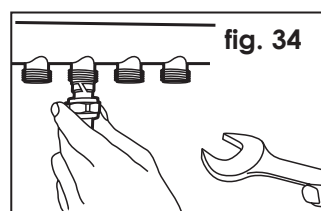
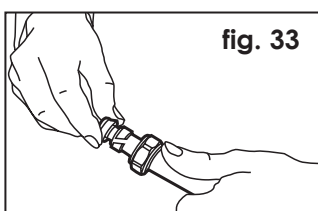

##### 1. ASSEMBLY OF SCREW FITTINGS (fig. 33, fig. 34)

a) Preparation of the MULTITUBO systems multi-layer pipe as described in point 3.1.1.  
b) Push the nut onto the pipe.

c) Push the clamping ring onto the pipe.  
d) Push the fitting as far as it will go into the pipe (fig. 35).  
e) Tighten the nut with a torque of 40 Nm (fig. 36).

**IMPORTANT: PLEASE MIND THAT THE FITTING IS NOT BEING PULLED OUT OF THE PIPE DURING TIGHTENING.**

### 3.0. Installation and assembly instructions

#### 3.2. Installation measures

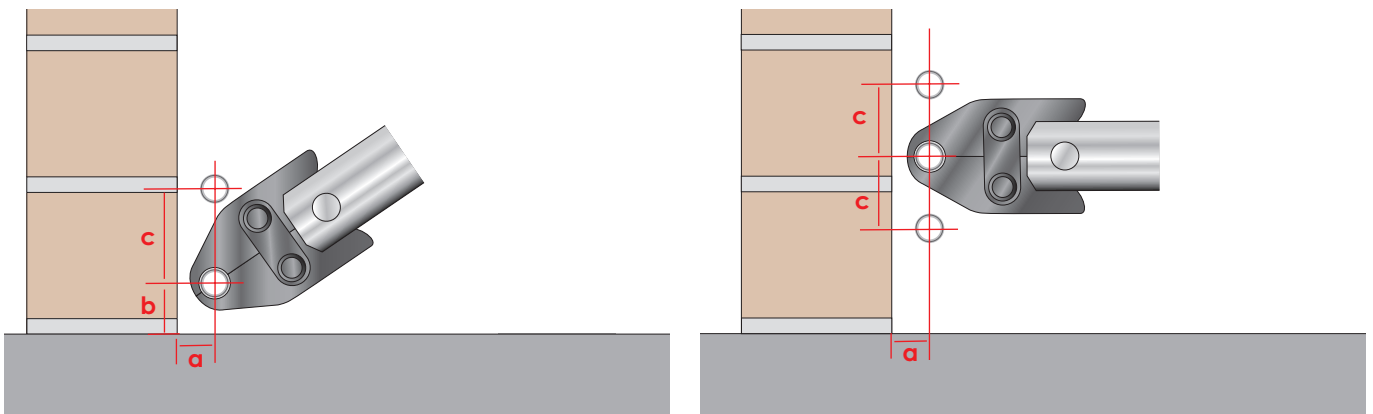

Pipe dimension (mm)	a (mm)	b (mm)	c (mm)
16 x 2.00	30	30	90
18 x 2.00	31	31	90
20 x 2.25	32	32	90
25 x 2.50	50	50	105
32 x 3.00	50	50	110
40 x 4.00	55	60	115
50 x 4.50	60	60	120
63 x 6.00	80	75	125
75 x 7.50	82	82	125
90 x 8.50	modular connection		
110 x 10.00	modular connection		

Pipe dimension (mm)	a (mm)	c (mm)
16 x 2.00	15	45
18 x 2.00	0	0
20 x 2.25	18	48
25 x 2.50	27	71
32 x 3.00	27	75
40 x 4.00	45	105
50 x 4.50	50	105
63 x 6.00	80	120
75 x 7.50	82	125
90 x 8.50	modular connection	
110 x 10.00	modular connection	

#### 3.3. Thermal expansion

The thermal expansion occurring during operation has to be taken into consideration during the installation process and the arrangement of the piping. The thermal expansion can be calculated by means of the following formula, and it is shown in the graph:

$\Delta l = \alpha \times L \times \Delta t$   
 Legend:  
 $\Delta l$ : Expansion (mm)  
 $\alpha$ : Coefficient of expansion (0,025 mm/(m x K))  
 $L$ : Length of pipeline (m)  
 $\Delta t$ : Difference of temperature (K)

#### Thermal expansion MULTITUBO multi-layer pipes

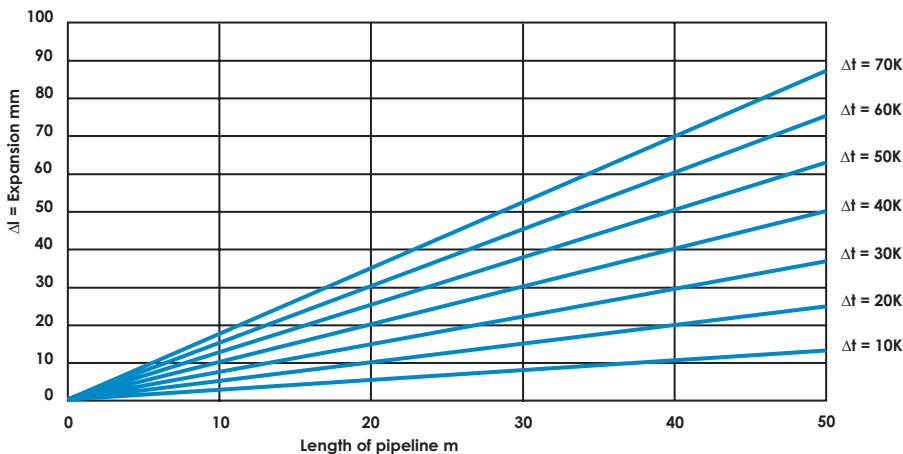

### 3.0. Installation and assembly instructions

#### 3.4. Thermal expansion of distribution lines and risers

For planning and installing MULTITUBO systems multi-layer pipes in distribution lines and risers, additional to the structurally engineered requirement, the thermal related length expansion must also be considered.

The multi-layer pipes must not be fixed between two fix-points. The length expansion of the pipes must always be absorbed respectively directed. On-wall installed MULTITUBO systems multi-layer pipes, which could be effected by a thermal expansion need adequate space for compensation.

For that, all positions of the fix-points must be known. The compensation is always between two fix-points (FP) and changes in direction (bending leg BL).

#### Scheme for length compensation at thermal length expansion

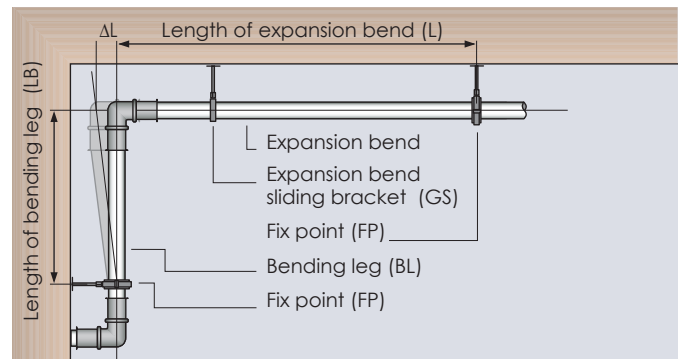

#### 3.5. Bending leg length

All pipes have to be arranged in such a way that the thermal expansion (warming and cooling) is not hindered. As a rule, the thermal expansion is regulated by a suitable arrangement of the piping. A pipe installation with bending leg is inevitable at changes of direction or at right-angled connections using the correct placing of slide and fixed points.

#### Determination of the bending leg length:

$$LB = C \sqrt{d \cdot \Delta L}$$

Legend:

LB = Length of bending leg [mm]

d = Outer diameter of pipe [mm]

ΔL = Expansion [mm]

C = Material-specific constant for MULTITUBO (= 30)

#### Determination of the bending leg length

#### Graphical determination of the bending leg length required

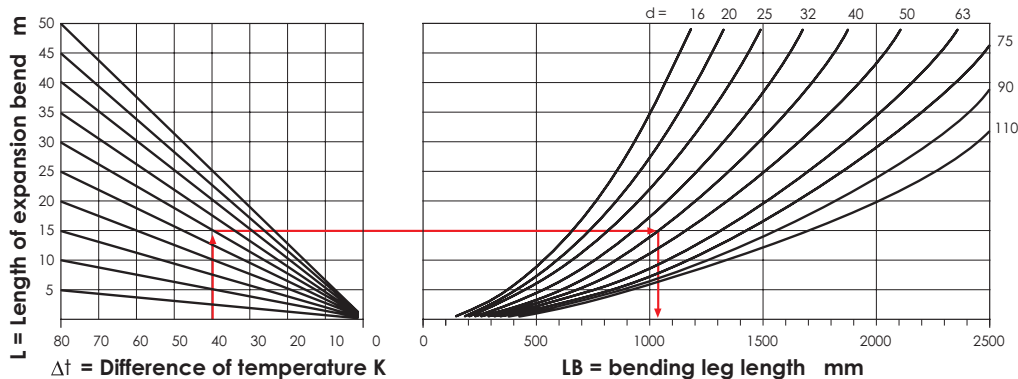

#### 3.6. Fastening technique

##### 3.6.1. Pipe fastening on the ceiling

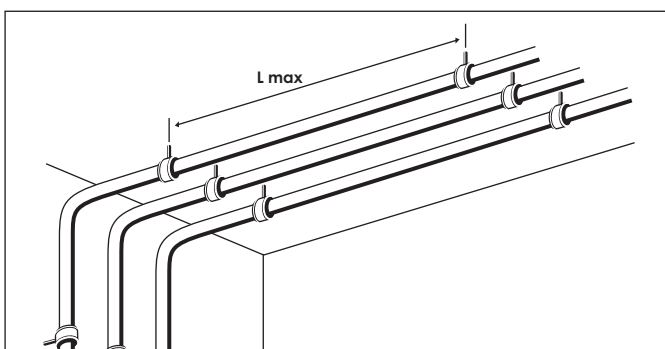

If MULTITUBO multi-layer pipes are openly installed on the ceiling, additional pipe supports are not necessary. The following chart shows the maximal fastening distances between the individual pipe clamps for the different pipe dimensions.

### 3.0. Installation and assembly instructions

#### 3.6. Fastening technique

##### 3.6.1. Pipe fastening on the ceiling

The type and the distance of the pipe fixing devices are depending on the pressure, the temperature and the medium. The dimensioning of the pipe clamps has to be carried out expertly taking into consideration the overall mass (weight of pipe + weight of the water inside + weight of insulation), observing the approved technical rules.

Dimension <b>da x s (mm)</b>	Maximum distance between pipe clamps L		Weight of pipe filled with water of 10 °C/without insulation	
	<b>horizontal (m)</b>	<b>vertical</b>	<b>Coil (kg/m)</b>	<b>Straight length (kg/m)</b>
16 x 2.00	1.20	1.55	0.218	0.218
18 x 2.00	1.20	1.60	0.273	0.273
20 x 2.25	1.30	1.70	0.338	0.338
25 x 2.50	1.50	1.95	0.529	0.529
32 x 3.00	1.60	2.10	0.854	0.854
40 x 4.00	1.70	2.20	-	1.310
50 x 4.50	2.00	2.60	-	2.062
63 x 6.00	2.20	2.85	-	3.265
75 x 7.50	2.40	3.10	-	4.615
90 x 8.50	2.40	3.10	-	6,730
110 x 10.00	2.40	3.10	-	9,959

##### 3.6.2. Pipe fastening on the bare floor

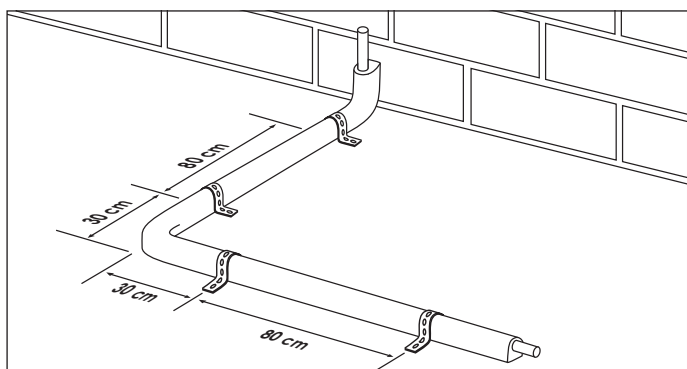

If MULTITUBO multi-layer pipes are installed on the floor or in the supporting floor, a fastening distance of 80 cm has to be observed. The distance between each bend and the fixing device before and after it must be 30 cm.

#### 3.7. Pipe bending

MULTITUBO multi-layer pipes in dimensions 16 – 25 mm can be bent easily by hand, with or without a bending spring, larger dimensions can be bent using a suitable bending tool.

Minimal bending radii:

Pipe dimension <b>mm</b>	bending radius by hand <b>mm</b>	bending radius with bending spring <b>mm</b>	bending radius with adequate bending tool <b>mm</b>
16 x 2.00	5 x OD ≈ 80	4 x OD ≈ 60	50
18 x 2.00	5 x OD ≈ 90	4 x OD ≈ 70	60
20 x 2.25	5 x OD ≈ 100	4 x OD ≈ 80	70
25 x 2.50	5 x OD ≈ 125	4 x OD ≈ 100	90
32 x 3.00	5 x OD ≈ 160	4 x OD ≈ 125	110
40 x 4.00	-	-	160
50 x 4.50	-	-	200
63 x 6,00	-	-	250
75 x 7,50	-	-	300

## 4.0. General technical information

### 4.1. Potential equalisation

The regulations VDE 0190 part 410 and 540 require a potential equalisation between protective conductors, „conductive“ water and heating pipes. As MULTITUBO multi-layer pipes are not conductive pipe installations, they cannot be used for potential equalisation and thus they need not be earthed.

An approved electrician has to check whether the MULTITUBO installation impairs the existing electrical protective and earthing arrangements (VOB part C General technical contract terms ATV).

### 4.2. Use of rainwater

The MULTITUBO system can be used for the installation in a rainwater utilisation installation. Regulations concerning the marking of the tapping locations as well as the drinking water feeding can be found in DIN 1988 part 4.

### 4.3. Installation in the mastic asphalt

A direct connection between MULTITUBO and the tar screed is not allowed. It has to be guaranteed by a suitable floor construction that the maximal allowed temperatures of the pipe system of 95 °C is not exceeded.

### 4.4. Connection to water heaters

A direct connection of the MULTITUBO multi-layer pipe without metal intermediary is always possible if the water heaters (flow heater, small and large water storage tanks) do not create higher temperatures than 95 °C in line with the standard regulations (DIN 4753, DIN VDE 0700, DIN 1988 DVGW).

### 4.5. Trace heating

MULTITUBO multi-layer pipes are suitable for the use of trace heating. The pipe's aluminium core guarantees an even heat transfer around the pipe. The choice and the fastening are carried out in line with the manufacturer's instructions; here the MULTITUBO multi-layer pipe is classified as a plastic pipe.

### 4.6. Antifreeze

MULTITUBO multi-layer pipes in building parts where frost can occur have to be protected from freezing.

### 4.7. Fire-protection

The structurally engineered requirements for fire-protection varies from area to area and thus the local requirements must be considered.

**Upfront, the designer and installer must check the actual valid local fire protection guidelines and laws before installation.**

### 4.7.1. Fire classification

To realise the local required fire protection guidelines, it is important to classify the used materials according to their fire-behaviour. For this all materials are classified into a fire classification according to a fire test (DIN 4102). Here all materials are tested on inflammability, flammability and gas release. The actual valid fire classification according to DIN 4102 will be replaced by a European classification in the future.

The MULTITUBO systems multi-layer pipes are in Fire classification class B2, "normal combustible", according to the new European classification they are in Fire classification class E (combustible, dripping off).

### 4.7.2. Fire Classification according to DIN 4102-1 and Euro classification

Requirement	DIN 4102 old	Euro classification new
non-combustible	A1	A1
	A2	A2
combustible	B1	B
		C
normal combustible	B2	D
		E
easy combustible	B3	F

### 4.8. Legionella

Measures to avoid legionella growth are stipulated in the work sheet W 551 by the DVGW.

Measures are, for example:

- potable water storage temperature of min. 60°C
- Avoidance of aerosol formation at tap fittings
- Avoidance of non-circulating installations without trace heating
- The cooling in the hot-water pipes and the circulation pipes must not be higher than 5 K

Existing studies show that it is not the material that favours the growth of legionella but the incrustation in the material.

### 4.10. Pipe installation in concrete, screed and in-wall

The MULTITUBO systems multi-layer pipe is protected by the outer PE layer. Considering the surface corrosion prevention, the installation of fittings in concrete, screed and in-wall is possible, though it must be insured that there is no permanent moisture penetration and no pH-values higher than 12.5.



## 4.0. General technical information

For such installations it is recommended to protect the connection with adequate coatings (e.g. duct tape, insulation tape, shrink-tape / -socket or something similar) against destructive influences.

All regulations and standards referring thermal and acoustic insulation are unaffected and must be considered.

The tightness test (pressure test) always has to be done before protection and / or insulation activities.

### 4.11. Installation in the soil, outdoor

The MULTITUBO systems multi-layer pipe is protected by the outer PE layer. An installation in the soil is possible, if following issues are considered:

- Pay attention to freeze protection, an adequate installation depth must be chosen.
- During installation or operating state no mechanical loads are allowed on the pipe (e.g. traffic-load)
- The refilling must be done with fine-grained materials. Coarse-grained and sharp-edged materials cause damages on the pipe.
- The fittings must be protected with corrosion protection tape against the soil.
- For outdoor application in the open air, the pipes must be protected against UV-radiation and mechanical impact.
- For this, multi-layer pipes in a protective tube can be used.

### 4.12. Application in compressed air systems

The MULTITUBO multi-layer pipe in connection with the press fittings is also suitable for compressed air installations. For the permanently tight connection the following parameters have to be observed:

Nominal pressure:	16 bar
Allowed excess working pressure:	12 bar
Maximal working temperature:	60°C
Minimum durability:	50 years
Safety factor:	1.3

In oil-free compressed air installations, for example as used in medicine technology, the MULTITUBO system can be used. In case of compressed air installations that are not oil-free, the MULTITUBO system is only suitable if only oils on silicon basis are used.

#### Note:

**Due to the valid German regulations it is not allowed to transport combustible and fire-promoting media (such as for example pure oxygen, acetylene, butane, etc.) through combustible pipe installations. Here above all local rules and regulations must be adhered to.**

### 4.13. Mounting instructions of screw connections

At installations of connections with threats, the mechanical impact has to be kept as low as possible to avoid material damages.

- Thus, the screw-connections should be done - if possible - before connecting the pipes to minimise the stress of the pipe connection.
- To tighten the screw connections, just suitable and approved materials must be used. Please check the respective manufacturer information.
- As each connection, the screw connection must be professionally connected according to rules of technology and under consideration of the MULTITUBO systems installation- and mounting instructions.
- Each kind of brute force must be avoided, like the increased effort that is needed when there is too much sealing tape put on the threat. Also an overly forced screwing in or extensions on the tool to generate an increased lever must be avoided.
- The used utilities like fitting aids, tightening- or cleaning agents must match the respective application purpose. They must not contain substances or compounds that cause stress-cracking corrosion (like ammoniac or chloride containing compounds).

### 4.14. Storage and assembly requirements

Apart from the assembly instructions of all devices and components, for **the storage and assembly of MULTITUBO multi-layer pipes** the following requirements have to be fulfilled (this is also valid for finished installation parts):

The assembly temperature for the pipe system should not be below -10°C. The working temperature of pressing tools must not be below 0°C and must not exceed 40°C. The optimal working temperature range for MULTITUBO system components is between 5°C and 25°C.

If the MULTITUBO multi-layer pipes are stored below -10°C, the pipes should be protected from mechanical damage. The pipes and fittings are optimally protected in the original packaging. The pipes should be protected from direct intensive solar radiation and load by UV radiation. This is both true for the storage and the installation of the pipes. Finished installation parts have to be correspondingly covered or protected from UV radiation by other suitable measures (for example insulation or installation in a protective pipe).

#### Solvents in direct contact with PPSU-Fittings

MULTITUBO systems PPSU fittings tolerate all components dissolved in non-hazardous potable- and heating water. Aggressive chemical substances used in solvents could interfere the mechanical properties of the PPSU material under certain circumstances and thus eventually harm the fitting.

Following working materials could contain solvents:

- polyurethane foam
- spray
- paint
- adhesive
- lubricant
- sealant
- two-part mortar
- cold flux

Please prevent the PPSU fitting to be in direct contact with solvents.

## 5.0. Technical information sanitary applications

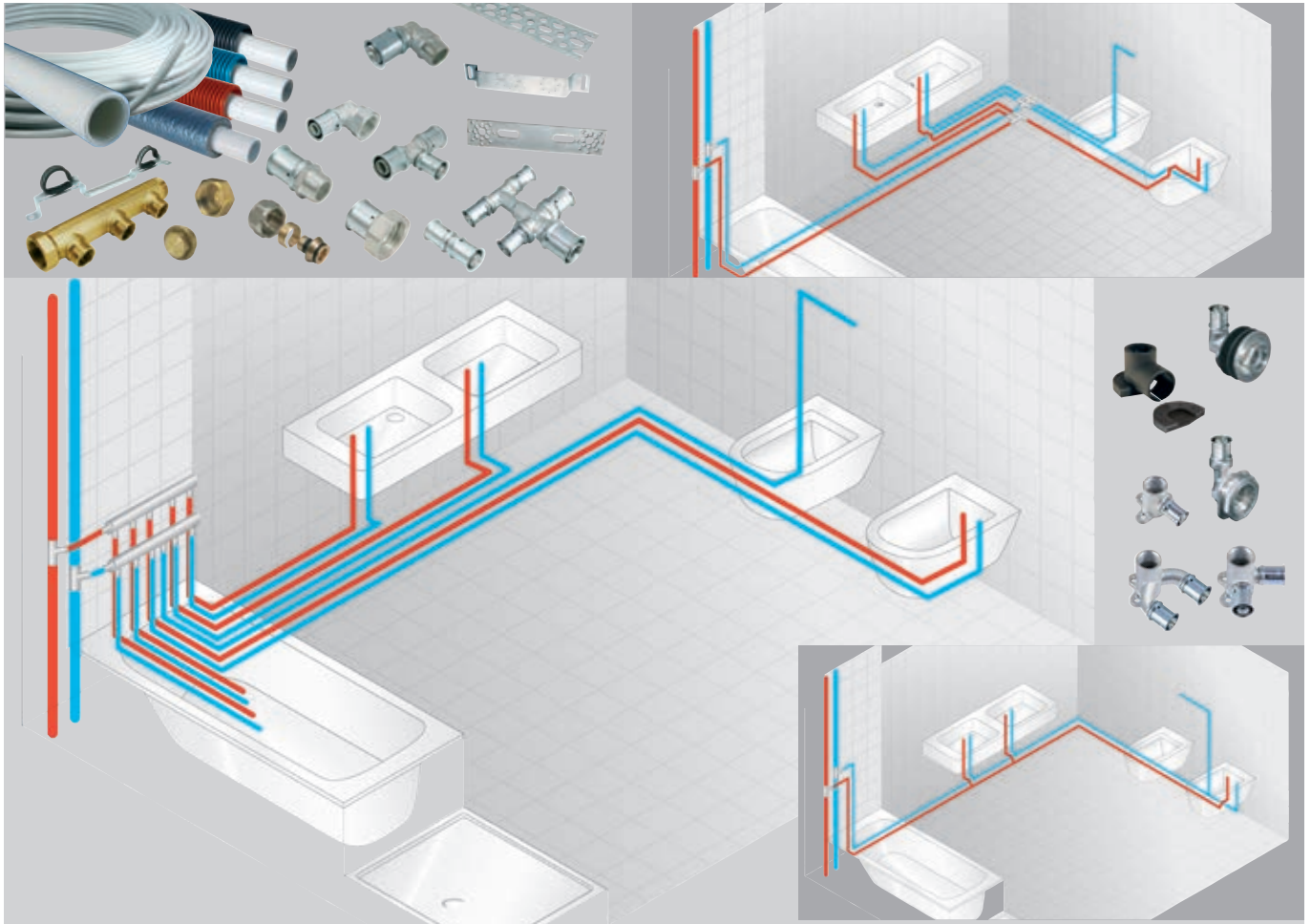

### 5.1. General information

MULTITUBO systems is a complete system for the entire sanitary installation from the house connection and the cellar piping, rising and distributing mains to the tapping point. The installation is possible in all sanitary rooms, for example for commercial and public buildings, for residential buildings and for communal washing troughs. It is perfectly suitable for drinking water installations for cold and hot water and circulation installations respectively. In the field of renovation, the clean and quick processing of

MULTITUBO systems using the press technique, without complicated welding, thread cutting, soldering or gluing, turns out to be an additional advantage.

All installations have to be carried out in line with the currently valid regulations and standards, inter alia concerning thermal insulation, sound insulation and fire protection.

### 5.2. Basis of design

#### 5.2.1. Dimensioning

The dimensioning and design of the MULTITUBO system is carried out on the basis of DIN 1988 part 3.

## 5.0. Technical information sanitary applications

### 5.2.2. Determination of the pipe friction resistance (Water 10 °C)

Vs l/s	16 x 2.00 DN 12 V/l = 0.11 l/m		18 x 2.00 DN 14 V/l = 0.15 l/m		20 x 2.25 DN 15 V/l = 0.19 l/m		25 x 2.50 DN 20 V/l = 0.31 l/m	
	v m/s	R hPa/m	v m/s	R hPa/m	v m/s	R hPa/m	v m/s	R hPa/m
0.01	0.09	0.22	0.06	0.11	0.05	0.07	0.03	0.02
0.02	0.18	0.69	0.13	0.34	0.11	0.21	0.06	0.06
0.03	0.27	1.36	0.19	0.66	0.16	0.41	0.10	0.13
0.04	0.35	2.21	0.26	1.07	0.21	0.66	0.13	0.20
0.05	0.44	3.23	0.32	1.56	0.26	0.97	0.16	0.30
0.06	0.53	4.41	0.39	2.13	0.32	1.32	0.19	0.40
0.07	0.62	5.75	0.45	2.78	0.37	1.72	0.22	0.52
0.08	0.71	7.23	0.52	3.49	0.42	2.16	0.25	0.66
0.09	0.80	8.86	0.58	4.28	0.48	2.68	0.29	0.80
0.10	0.88	10.63	0.65	5.13	0.53	3.17	0.32	0.96
0.15	1.33	21.49	0.97	10.35	0.79	6.39	0.48	1.94
0.20	1.77	35.52	1.30	17.08	1.06	10.54	0.64	3.20
0.25	2.21	52.55	1.62	25.24	1.32	15.56	0.80	4.73
0.30	2.65	72.43	1.95	34.76	1.59	21.41	0.95	6.51
0.35	3.09	95.07	2.27	45.59	1.85	28.07	1.11	8.55
0.40	3.54	120.39	2.60	57.70	2.12	35.52	1.27	10.84
0.45	3.98	148.33	2.92	71.05	2.38	43.72	1.43	13.36
0.50	4.42	178.83	3.25	85.62	2.65	52.67	1.59	16.12
0.55	4.86	211.85	3.57	101.38	2.91	62.35	1.75	19.11
0.60	5.31	247.33	3.90	118.31	3.18	72.74	1.91	22.33
0.65	5.75	285.24	4.22	136.40	3.44	83.84	2.07	25.78
0.70	6.19	325.56	4.55	155.63	3.71	95.64	2.23	29.45
0.75	6.63	368.25	4.87	175.98	3.97	10.13	2.39	33.35
0.80	7.07	413.27	5.20	197.44	4.24	121.29	2.55	37.47
0.85			5.52	219.99	4.50	135.12	2.71	41.80
0.90			5.85	243.63	4.77	149.62	2.86	46.36
0.95			6.17	268.35	5.03	164.77	3.02	51.13
1.00			6.50	294.13	5.30	180.57	3.18	56.12
1.05			6.82	320.97	5.56	197.02	3.34	61.32
1.10			7.15	348.86	5.83	214.11	3.50	66.74
1.15					6.09	231.84	3.66	72.36
1.20					6.36	250.19	3.82	78.21
1.25					6.62	269.17	3.98	84.26
1.30					6.89	288.77	4.14	90.52
1.35							4.30	96.99
1.40							4.46	103.67
1.45							4.62	110.56
1.50							4.77	117.65
1.60							4.93	124.96
1.70							5.41	148.11
1.80							5.73	164.57
1.90							6.05	181.86

Vs l/s	32 x 3.00 DN 25 V/l = 0.53 l/m		40 x 4.00 DN 32 V/l = 0.80 l/m	
	v m/s	R hPa/m	v m/s	R hPa/m
0.10	0.19	0.28	0.12	0.10
0.20	0.38	0.91	0.25	0.34
0.30	0.57	1.84	0.37	0.69
0.40	0.75	3.03	0.50	1.13
0.50	0.94	4.48	0.62	1.67
0.60	1.13	6.17	0.75	2.30
0.70	1.32	8.10	0.87	3.01
0.80	1.51	10.25	0.99	3.81
0.90	1.70	12.63	1.12	4.69
1.00	1.88	15.22	1.24	5.65
1.10	2.07	18.02	1.37	6.69
1.20	2.26	21.03	1.49	7.80
1.30	2.45	24.24	1.62	8.99
1.40	2.64	27.66	1.74	10.25
1.50	2.83	31.28	1.87	11.59
1.60	3.01	35.09	1.99	13.00
1.70	3.20	39.10	2.11	14.48
1.80	3.39	43.30	2.24	16.03
1.90	3.58	47.69	2.36	17.65
2.00	3.77	52.27	2.49	19.34
2.10	3.96	57.04	2.61	21.10
2.20	4.14	61.99	2.74	22.92
2.30	4.33	67.13	2.86	24.82
2.40	4.52	72.45	2.98	26.78
2.50	4.71	77.96	3.11	28.81
2.60	4.90	83.64	3.23	30.90
2.70	5.09	89.50	3.36	33.06
2.80	5.27	102.43	3.48	35.28
2.90	5.46	109.28	3.61	37.57
3.00	5.65	116.35	3.73	39.93
3.10	5.84	123.62	3.85	44.68
3.20	6.03	131.09	3.98	47.36
3.30	6.22	138.78	4.10	50.11
3.40	6.40	146.68	4.23	52.93
3.50	6.59	154.78	4.35	55.82
3.60	6.78	163.09	4.48	58.79
3.70			4.60	61.83
3.80			4.72	64.94
3.90			4.85	68.12
4.00			4.97	71.37
4.50			5.60	88.71
5.00			6.22	107.83

Vs = Peak flow of water [l/s], v = Flow rate [m/s],  
R = Pipe friction-pressure loss [hPa/m]

Vs = Peak flow of water [l/s], v = Flow rate [m/s],  
R = Pipe friction-pressure loss [hPa/m]

## 5.0. Technical information sanitary applications

### 5.2.2. Determination of the pipe friction resistance (Water 10 °C)

50 x 5.00 DN 40 V/l = 1.32 l/m		
Vs l/s	v m/s	R hPa/m
0.10	0.08	0.03
0.20	0.15	0.11
0.30	0.23	0.21
0.40	0.30	0.35
0.50	0.38	0.52
0.60	0.45	0.72
0.70	0.53	0.94
0.80	0.61	1.19
0.90	0.68	1.46
1.00	0.76	1.76
1.10	0.83	2.09
1.20	0.91	2.43
1.30	0.98	2.81
1.40	1.06	3.20
1.50	1.14	3.62
1.60	1.21	4.07
1.70	1.29	4.53
1.80	1.36	5.02
1.90	1.44	5.53
2.00	1.51	6.07
2.10	1.59	6.62
2.20	1.67	7.20
2.30	1.74	7.80
2.40	1.82	8.42
2.50	1.89	9.07
2.60	1.97	9.73
2.70	2.05	10.42
2.80	2.12	11.13
2.90	2.20	11.86
3.00	2.27	12.31
3.10	2.35	13.38
3.20	2.42	14.17
3.30	2.50	14.99
3.40	2.58	15.82
3.50	2.65	16.68
3.60	2.73	17.55
3.70	2.80	18.45
3.80	2.88	19.37
3.90	2.95	20.31
4.00	3.03	21.27
4.50	3.41	26.37
5.00	3.79	31.99
5.50	4.17	38.10
6.00	4.54	44.72
6.50	4.92	51.83
7.00	5.30	59.44
7.50	5.68	67.54
8.00	6.06	76.12
8.50		

Vs = Peak flow of water [l/s],  
v = Flow rate [m/s],  
R = Pipe friction-pressure loss [hPa/m]

63 x 6.00 DN 51 V/l = 2.04 l/m			75 x 7.50 DN 60 V/l = 2.83 l/m		90 x 8.50 V/l = 4.18 l/m		110 x 10.00 V/l = 6.36 l/m	
Vs l/s	v m/s	R hPa/m	v m/s	R hPa/m	v m/s	R hPa/m	v m/s	R hPa/m
1.00	0.49	0.61	0.35	0.28	0.24	0.11	0.16	0.04
1.25	0.61	0.91	0.44	0.42	0.30	0.17	0.20	0.06
1.50	0.73	1.25	0.53	0.58	0.36	0.23	0.24	0.08
1.75	0.86	1.65	0.62	0.76	0.42	0.30	0.28	0.11
2.00	0.98	2.08	0.71	0.96	0.48	0.38	0.31	0.14
2.25	1.10	2.57	0.80	1.18	0.54	0.46	0.35	0.17
2.50	1.22	3.10	0.88	1.43	0.60	0.56	0.39	0.21
2.75	1.35	3.67	0.97	1.69	0.66	0.66	0.43	0.24
3.00	1.47	4.28	1.06	1.97	0.72	0.77	0.47	0.28
3.25	1.59	4.94	1.15	2.27	0.78	0.89	0.51	0.33
3.50	1.71	5.64	1.24	2.59	0.84	1.01	0.55	0.37
3.75	1.84	6.38	1.33	2.93	0.90	1.15	0.59	0.42
4.00	1.96	7.16	1.41	3.29	0.96	1.29	0.63	0.47
4.25	2.08	7.98	1.50	3.66	1.02	1.43	0.67	0.53
4.50	2.20	8.84	1.59	4.06	1.08	1.59	0.71	0.58
4.75	2.33	9.73	1.68	4.47	1.13	1.75	0.75	0.64
5.00	2.45	10.67	1.77	4.90	1.19	1.92	0.79	0.70
6.00	2.94	14.80	2.12	6.79	1.43	2.65	0.94	0.97
7.00	3.43	19.53	2.48	8.95	1.67	3.49	1.10	1.28
8.00	3.92	24.84	2.83	11.38	1.91	4.44	1.26	1.63
9.00	4.41	30.71	3.18	14.07	2.15	5.49	1.41	2.01
10.00	4.90	37.15	3.54	17.01	2.39	6.63	1.57	2.43
11.00	5.38	44.13	3.89	20.20	2.63	7.87	1.73	2.88
12.00			4.24	23.63	2.87	9.21	1.89	3.37
13.00			4.60	27.31	3.11	10.63	2.04	3.89
14.00			4.95	31.23	3.34	12.16	2.20	4.45
15.00			5.31	35.38	3.58	13.77	2.36	5.03
16.00			5.66	39.77	3.82	15.47	2.52	5.65
17.00			6.01	44.39	4.06	17.27	2.67	6.31
18.00					4.30	19.15	2.83	6.99
19.00					4.54	21.12	2.99	7.71
20.00					4.78	23.17	3.14	8.46
21.00					5.02	25.31	3.30	9.24
22.00					5.26	27.54	3.46	10.05
23.00					5.50	29.86	3.62	10.89
24.00					5.73	32.25	3.77	11.77
25.00							3.93	12.67
26.00							4.09	13.60
27.00							4.24	14.57
28.00							4.40	15.56
29.00							4.56	16.58
30.00							4.72	17.63

Vs = Peak flow of water [l/s], v = Flow rate [m/s],  
R = Pipe friction-pressure loss [hPa/m]

## 5.0. Technical information sanitary applications

### 5.2.3. Pressure loss graph

The pressure loss graph includes the piping characteristic curve with the different dimensions for MULTITUBO multi-layer pipes well as the limit lines of the flow rates.

By means of the graph, at a given volume flow or flowing-through respectively, the pipe friction resistance per metre in the pipe dimension and the flow rate can be determined in a simple graphic way.

### Pipe friction-pressure loss of MULTITUBO multi-layer pipes (Water 10 °C)

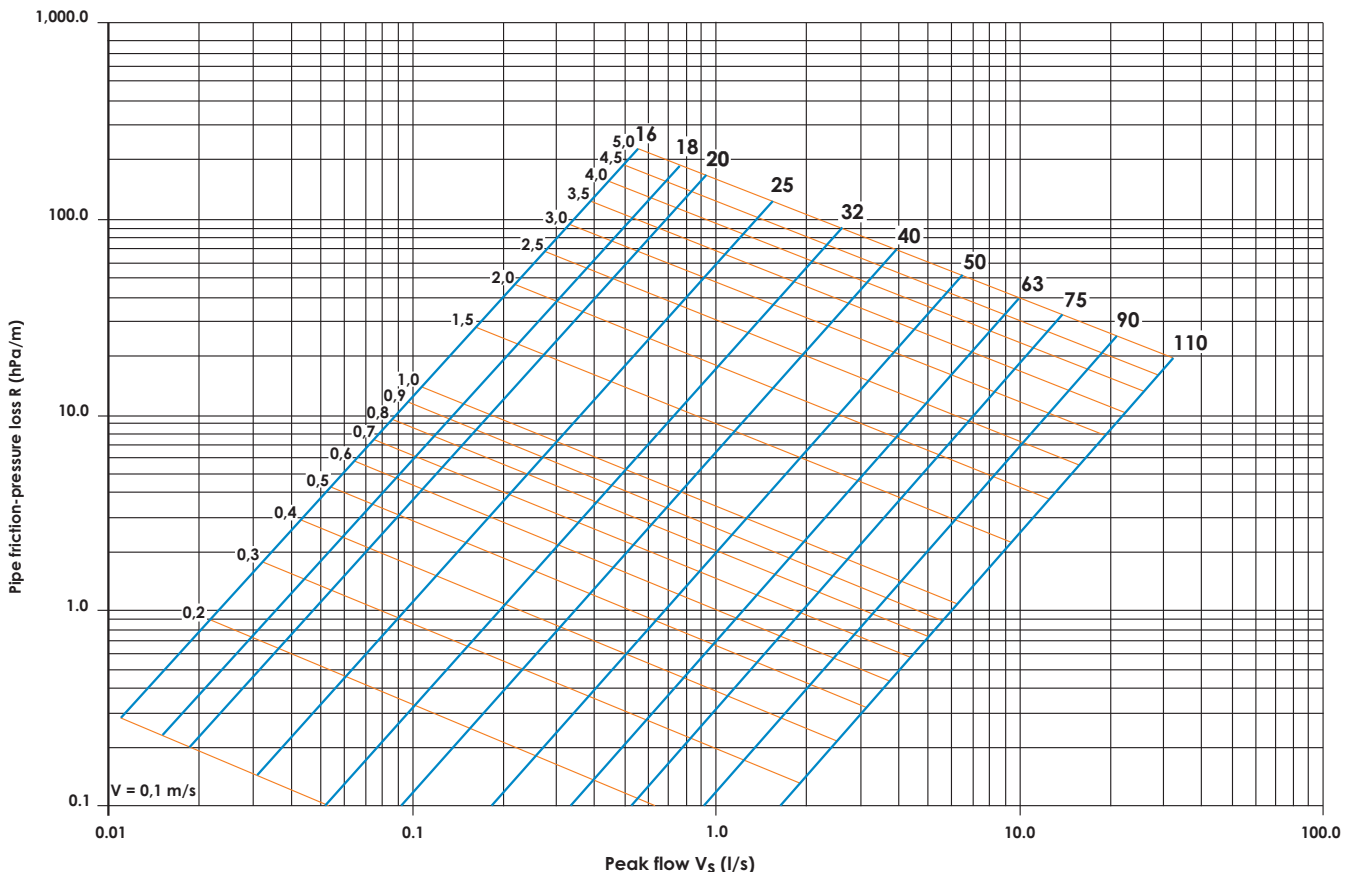

## 5.3. Pressure test

### 5.3.1. Pressure test with water

According to DIN 1988, for MULTITUBO systems a pressure test has to be carried out in an uncovered state after finishing.

At first each connection has to be checked visually for the correct pressing. Only pressure gauges are suitable for the test that allows a clear reading of a pressure change of 0.1 bar.

The pressure gauge has to be installed at the lowest point of the installation to be tested.

#### Preliminary test:

The working pressure plus 5 bar has to be applied as test pressure (15 bar) during the preliminary test. This test pressure has to be brought to the initial test pressure twice within 30 minutes at an interval of 10 minutes each. Afterwards the test pressure must not fall by more than 0.6

bar (0.1 bar per 5 minutes) after 30 minutes and leakages must not occur.

#### Main test:

The main test is carried out directly after the preliminary test. The test pressure read after the preliminary test must not have been fallen by more than 0.2 bar after two hours. Leakages must not be detected at any point of the tested installation.

## 5.0. Technical information sanitary applications

### 5.3.1. Pressure test with water

#### Additional test safety (Metal-Press fittings (16 mm - 32 mm) and PPSU-Press fittings (16 mm - 50 mm))

The press - fittings from dim 16 to 32 mm of the MULTITUBO systems plumbing system have an additional test safety feature. That means that the installer - when original MULTITUBO systems tools were used - is able to detect non-pressed connections during a pre-pressure test of min. 15 minutes with 1.5 bar. After that pretest, the pressure test procedure is done separately.

### 5.3.2. Pressure test with air or inert gases

Alternatively to the pressure test with water, the pressure test for the MULTITUBO installation system can also be carried out using compressed air or inert gases. This is particularly recommended in the freezing period. Here, the ZVSHK information "Execution of a pressure test with compressed air or inert gases for drinking water installati-

ons according to DIN 1988/TRWI" has to be observed.

### 5.3.3. Pipe flushing

After the pressure test, the complete installation has to be flushed thoroughly. The procedure for the pipe flushing is described in DIN 1988 T2 section 11.2.

### 5.3.4. Pressure test protocol for sanitary applications

In order to comply with our liability regulations, the system must be tested in accordance to the specifications of our pressure test protocols. The test reports can be downloaded from our website or requested directly from us.

## 6.0. Technical information radiator connection

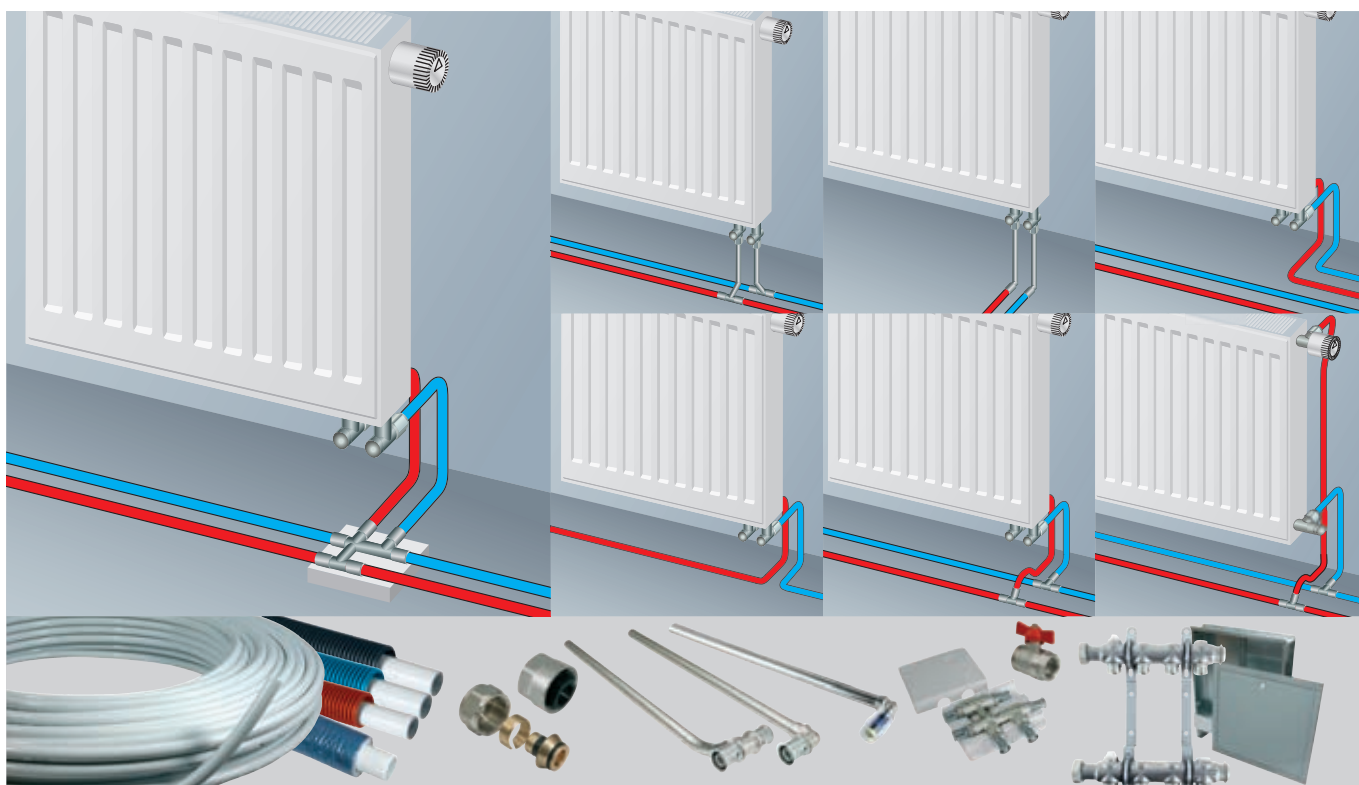

### 6.1. Technical information radiator connection

MULTITUBO systems allow the complete installation of heating facilities from the heat generator to the radiator. Both single pipe connections and two-pipe connections are possible without any problems.

Not only in a new building, but also in the field of the reconstruction of old buildings the press connection technique, which allows an installation without soldering and welding, shows its clear advantages.

All installations must be carried out in line with the current

ly valid regulations and standards, inter alia thermal insulation, sound protection and fire protection.

**Important information: Installations such as solar or long-distance energy installations, which are operated with working temperatures exceeding 95 °C, must not be connected directly to MULTITUBO systems! It has to be guaranteed in every working situation that the operating limits of MULTITUBO multi-layer pipes are not exceeded.**

## 6.0. Technical information radiator connection

### 6.2. Pressure loss graph

The pressure loss graph includes the piping characteristic curve for MULTITUBO with the different dimensions as well as the limit lines of the flow rates. By means of the graph, for the spread  $T = 20\text{ K}$  at an average

water temperature of  $60\text{ °C}$  and at a given flow (volume flow), the pipe friction resistance per metre in dependence of the pipe dimension and the flow rate can be determined in a simple graphic way.

**Pressure-loss, depending on the mass flow (Water  $60\text{ °C}$ )**

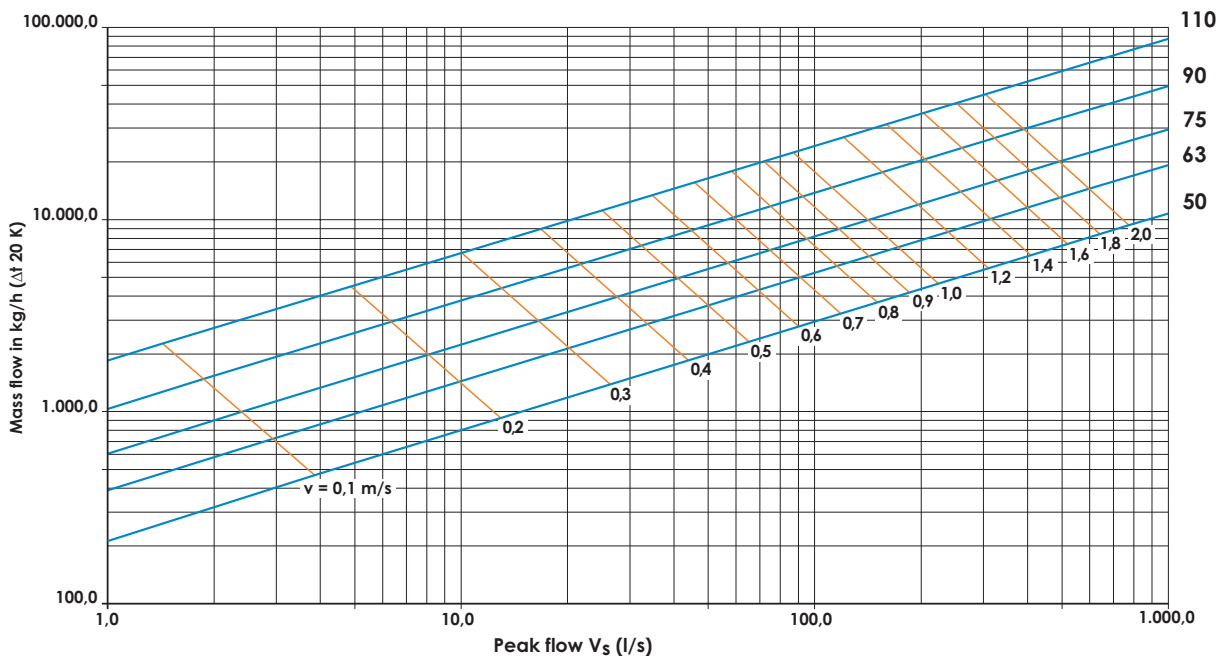
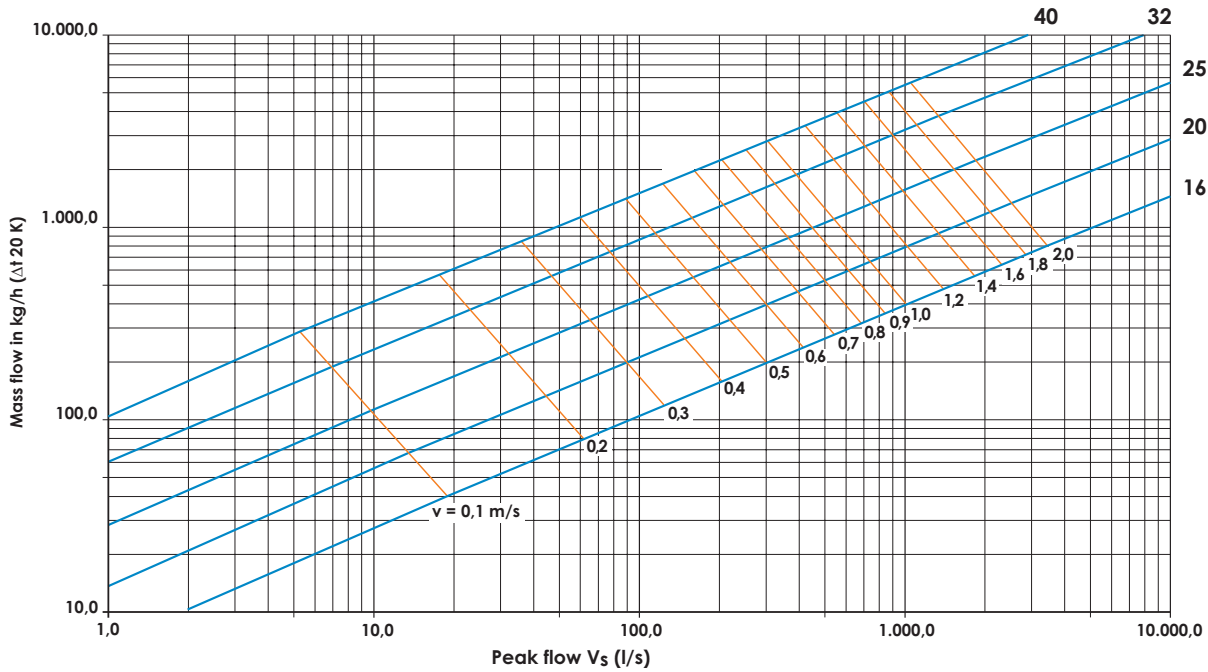

## 6.0. Technical information radiator connection

### 6.3. Heat capacity of MULTITUBO multi-layer pipes

#### Heat capacity of MULTITUBO multi-layer pipes

Radiator connection pipeline:	≤ 0.3 m/s					
Pipe dimension	16 x 2.00	18 x 2.00	20 x 2.25	25 x 2.50	32 x 3.00	
Mass flow (kg/h)	122	166	204	339	573	
Heat capacity (W) at ΔT = 20K	2,840	3,865	4,738	7,889	13,332	
Heat capacity (W) at ΔT = 15K	2,130	2,899	3,554	5,916	9,999	
Heat capacity (W) at ΔT = 10K	1,420	1,933	2,369	3,944	6,666	
Heat capacity (W) at ΔT = 5K	710	966	1,185	1,972	3,333	

Heating distribution pipeline:	≤ 0.5 m/s					
Pipe dimension	16 x 2.00	18 x 2.00	20 x 2.25	25 x 2.50	32 x 3.00	40 x 4.00
Mass flow (kg/h)	204	277	340	565	956	1,448
Heat capacity (W) at ΔT = 20K	4,733	6,442	7,897	13,148	22,119	33,658
Heat capacity (W) at ΔT = 15K	3,550	4,832	5,923	9,861	16,665	25,243
Heat capacity (W) at ΔT = 10K	2,367	3,221	3,948	6,574	11,110	16,829
Heat capacity (W) at ΔT = 5K	1,183	1,611	1,974	3,287	5,555	8,414

Risers and basement distribution pipeline:	≤ 1.0 m/s					
Pipe dimension	16 x 2.00	18 x 2.00	20 x 2.25	25 x 2.50	32 x 3.00	40 x 4.00
Mass flow (kg/h)	407	554	679	1,131	1,911	2,895
Heat capacity (W) at ΔT = 20K	9,466	2,885	15,794	26,295	44,439	67,316
Heat capacity (W) at ΔT = 15K	7,100	9,663	11,845	19,721	33,329	50,487
Heat capacity (W) at ΔT = 10K	4,733	6,442	7,897	13,148	22,219	33,698
Heat capacity (W) at ΔT = 5K	2,367	3,221	3,948	6,574	11,110	16,829

### 6.4. Pressure test

For MULTITUBO systems, a leak test has to be carried out according to DIN 18380. This test has to be executed after the installation and before the wall slots and cut-throughs of walls and ceilings are closed

At first, a visual check of each connection point for proper pressing has to be carried out.

Hot water heating systems must be tested with a pressure of the 1.3-fold of the total pressure at all points of the installation, but at least with 1 bar excess pressure. Immediately after the cold water test, the impermeability at the maximum temperature must be tested by means of heating up to the highest heating water temperature that was the basis for the calculation.

#### Additional test safety (Metal-Press fittings (16 mm - 32 mm) and PPSU-Press fittings, (16 mm - 50 mm))

The press - fittings from dim 16 to 32 mm of the MULTITUBO systems plumbing system have an additional test safety feature. That means that the installer - when original MULTITUBO systems tools were used - is able to detect non-pressed connections during a pre-pressure test of min. 15 minutes with 1.5 bar. After that pretest, the pressure test procedure is done separately.

If radiators are already connected during the pressure test, the maximum pressure requirements of the radiator supplier must be considered.

#### 6.4.1. Pressure test protocol for radiator connection

In order to comply with our liability regulations, the system must be tested in accordance to the specifications of our pressure test protocols. The test reports can be downloaded from our website or requested directly from us.



## 7.0. Technical information radiant heating/cooling

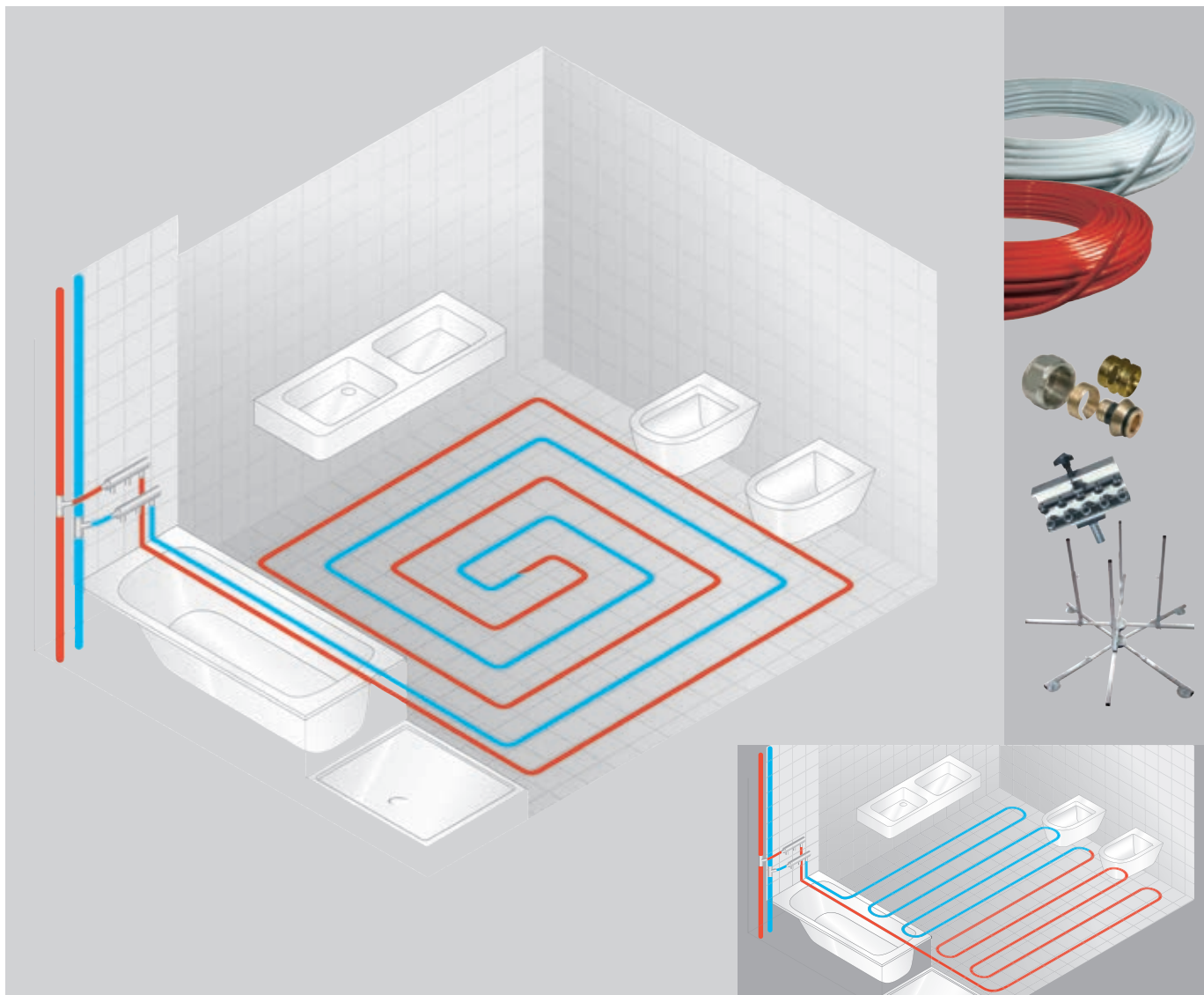

### 7.1. General information

Today, the radiant heating/cooling is becoming more and more important because of the use of the most modern heating/cooling and control technology. With its white multi-layer pipe, or with the red multi-layer pipe particularly suitable for radiant heating/cooling, MULTITUBO systems offers pipes which have decisive advantages concerning reliability, durability and easy handling. These pipes fulfil all occurring requirements, such as for example absolute oxygen tightness, a low thermal expansion, they are flexible, can be bent easily

by hand, they are absolutely corrosion-resistant, maintenance-free and offer a quick and easy installation. Here the MULTITUBO multi-layer pipe can be combined with many underfloor heating/cooling components (distributors, pipe positioning plates, tacker systems, dry construction systems etc.) available on the market.

**To guarantee a correct operation of the system, please mind the technical rules of heating and cooling installations to prevent damage from health and building.**

## 7.0 Technical Instruction panel heating

### 7.2. Laying systems

In general there are two different types of laying for underfloor heating systems:

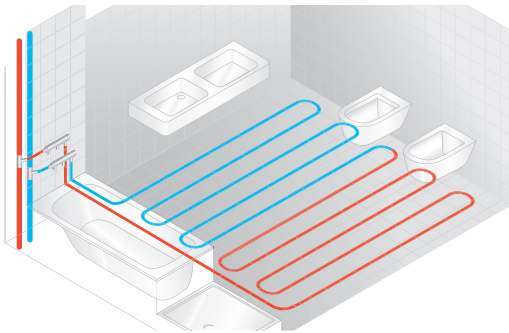

#### Meander laying

At the meander laying the pipe is laid from the exterior wall to the inner wall of the room resulting from the decreasing heat-capacity of the pipe.

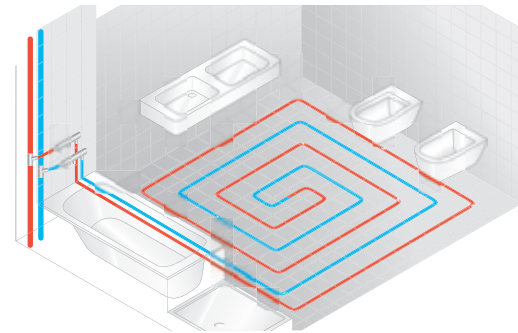

#### Counterflow laying

At the counterflow laying the pipe is positioned helical. Due to the declining heat load in the pipe and that the "flow" is always next to the "return" the heat emission is nearly the same all-over the room.

### 7.3. Fringe area

In rooms with big windows or at exterior walls a fringe area with narrow pipe spacing can be laid. So cooler parts of the room or steaming up of the windows can be avoided. Meander or Counterflow laying are suitable for those fringe areas, but the min. bending radii of the pipe must be considered. Resulting from this a Counterflow laying with an adequate turning-back loop in fringe areas with a pipe spacing less than 15 cm is in general more suitable.

- a - Exterior wall with window
- b - Turning back loop of the Counterflow laying in the fringe area
- c - Continued laying system: Meander laying

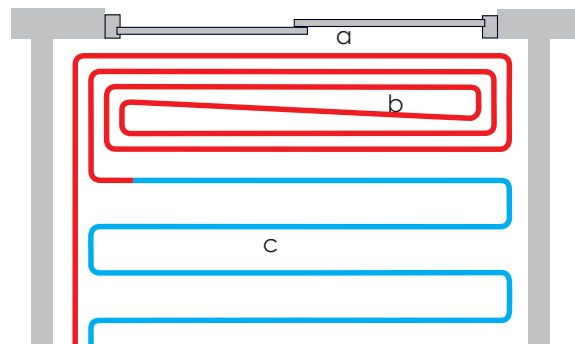

### 7.4. Expansion joints

In general all fixed parts must be isolated against noise by using edging strips before placing the screed. Depending on the structural situation additional movement joints must be placed – see DIN EN 1264-4 (German institute for standardisation – European standard):

- Screed surface > 40 m<sup>2</sup>
- Lateral length > 8 m
- Width-to-length ratio w/l > 1/2
- Movement-joint below the screed
- Strong staggered screed surface

When passing the pipe through the expansion joint, the pipe has to be protected against mechanical loads by using joint protection pipe.

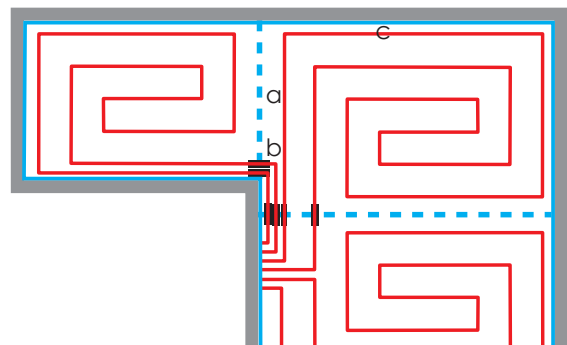

- a – Expansion joint with expansion joint profile
- b – Pipe penetration through the expansion joint with joint protection pipe
- c – Edging strip to avoid a sound bridge

## 7.0 Technical Instruction panel heating

### 7.5. Calculation diagram underfloor heating

#### Thermal resistance of various floor coverings:

Tiles, marble:	$R_{\lambda a} = 0,00 \text{ (m}^2\text{K)W}$
PVC:	$R_{\lambda a} = 0,05 \text{ (m}^2\text{K)W}$
Parquet:	$R_{\lambda a} = 0,10 \text{ (m}^2\text{K)W}$
Carpet:	$R_{\lambda a} = 0,15 \text{ (m}^2\text{K)W}$

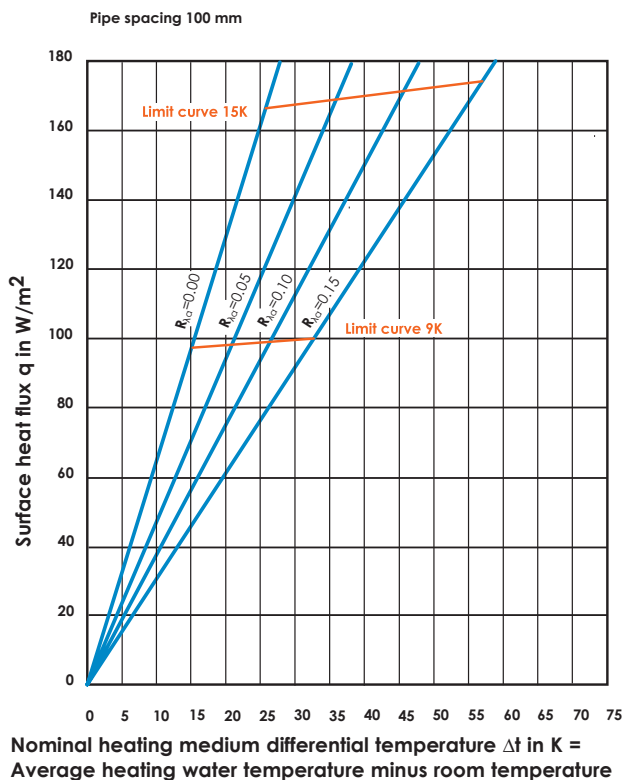
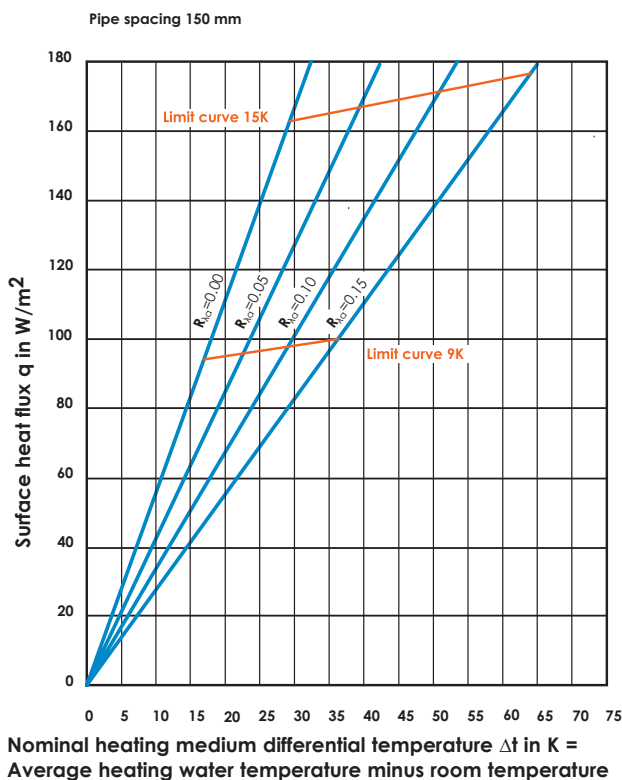
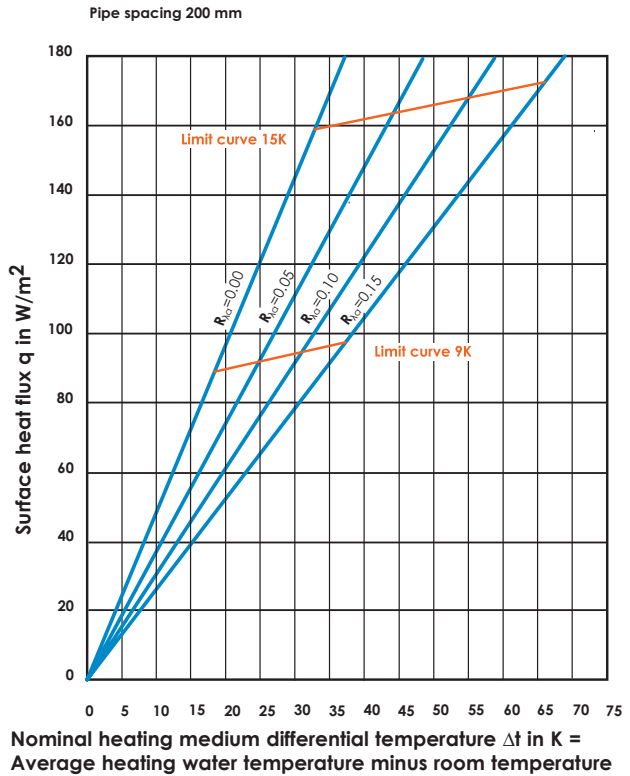
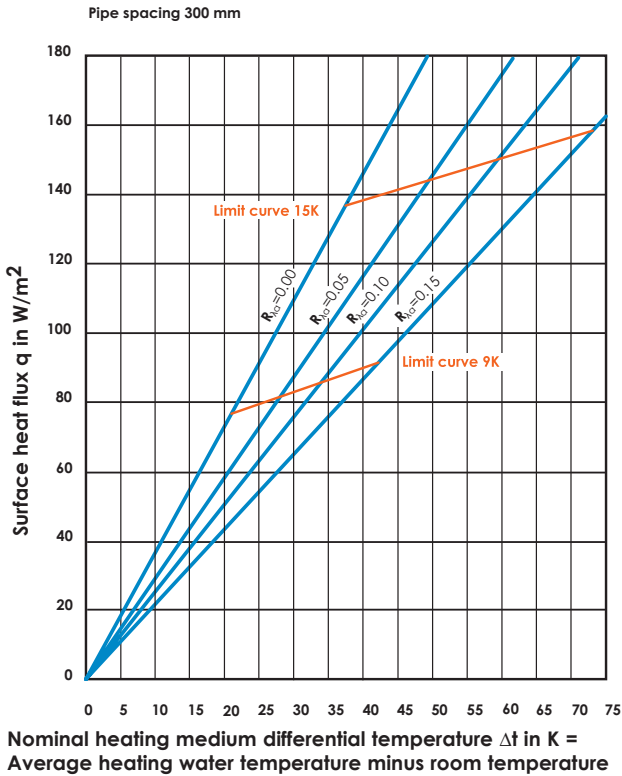

## 7.0 Technical Instruction panel heating

### 7.6. Pressure-loss diagram

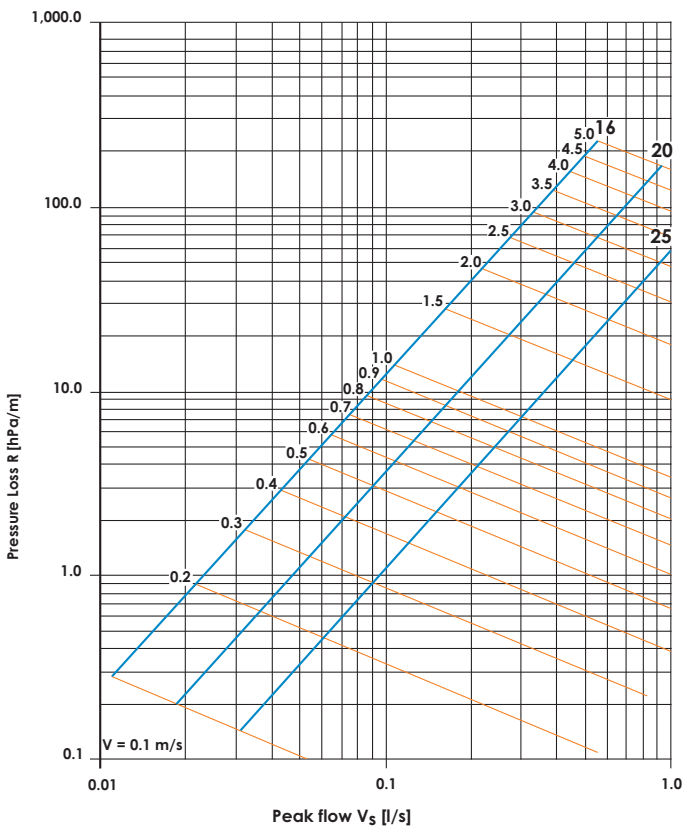

### 7.7. Pipe spacing and corresponding pipe demand

Pipe spacing [cm]	10	15	20	25	30
Pipe demand [m/m <sup>2</sup> ]	10.00	6.70	5.00	4.00	3.40

## 8.0. Service

### International partnership

International partnership for MULTITUBO is a topic with outstanding meaning. The idea of a system that will serve with high quality and practical solutions for the daily challenge on building sites demands a good communication with our partners. We try to provide a close contact to all the questions and suggestions the market could have to improve our products and us.

If there are any questions about our products or technical features, please do not hesitate to contact our partner or us directly:

### 7.8. Pressure test

The pressure test for underfloor heating circulation installations with the MULTITUBO multi-layer pipe must be carried out following DIN EN 1264-4. Only pressure gauges are to be used for the test that allows a clear reading of a pressure change of 0.1 bar.

After completion, the heating circuits must be tested for leakages by means of a water pressure test. Before the water pressure test, all heating circuits must be filled completely and must be de-aired. The impermeability must be guaranteed immediately before and during the floor screed works.

The level of the test pressure is at least the 1.3-fold of the maximally allowed working pressure.

We recommend a test with at least 5 bar and maximal 6 bar during 24 hours, here it has to be observed that the stop valves before and after the underfloor heating distributor are closed, so that the test pressure is kept away from the rest of the installation.

The test pressure must not fall by more than 0.2 bar. Leakages must not occur at any point of the tested installation. At the laying of the floor pavement, the test pressure has to be adapted to the highest allowed working pressure of the installation.

#### 7.8.1. Pressure test protocol for panel heating

In order to comply with our liability regulations, the system must be tested in accordance to the specifications of our pressure test protocols. The test reports can be downloaded from our website or requested directly from us.

### Contact

DW Verbundrohr GmbH  
Langer Rain 38  
97437 Hassfurt/Germany

Fon +49 (0) 95 21/95 35 6-0  
Fax +49 (0) 95 21/95 35 6-9

e-mail [info@multitubo.eu](mailto:info@multitubo.eu)  
net [www.multitubo.eu](http://www.multitubo.eu)

Valid for all products of multitubo systems delivered by us with the exception of electronic components

## Warranty

### MULTITUBO systems tap water and heating connection system

All components of the multitubo systems are made from high quality materials. The most important parameters and attributes are constantly checked during quality assurance.

Multitubo systems consist of multilayer pipes, fittings and accessories.

For damages occurring at our products within 10 years after the date of delivery and which are provably resulting from faults in production or material we perform free insurance cover.

For other damages (personal injury and damage to property) as well as for all costs for dismantling, removal, and re-installation we are liable in the extent in which our business liability insurance and product liability insurance pays compensation.

The sums insured are the following:

**EUR 3.000.000 for bodily injury and property damage**

DW Verbundrohr GmbH does not assume liability for improper assembly or installation.

DW Verbundrohr GmbH  
Langer Rain 38  
D-97437 Hassfurt  
Germany

